

P7886 (S)(E)

2(1)(0.5) GHz Time-of-Flight / Multiscaler

User Manual

Copyright FAST ComTec GmbH
Grünwalder Weg 28a, D-82041 Oberhaching
Germany

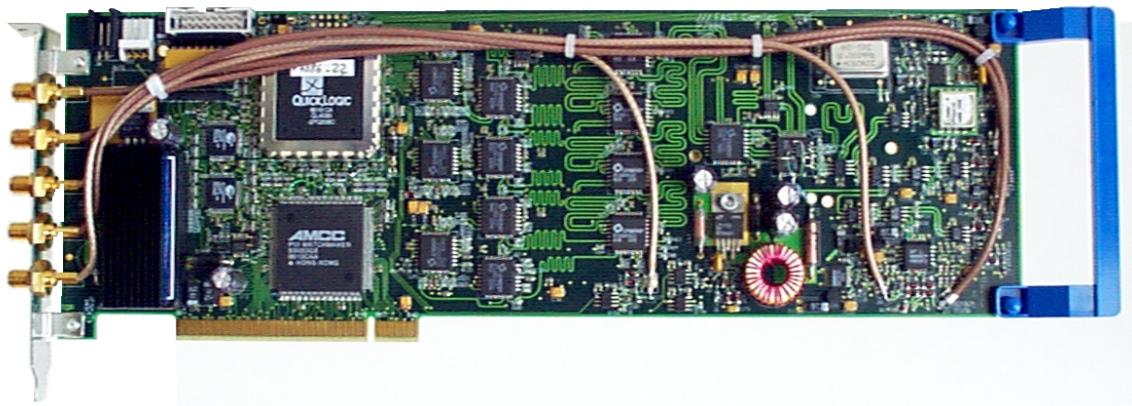

Version 2.0, March 9, 2000

Warranty Information

FAST ComTec warrants proper operation of this software only when used with software and hardware supplied by FAST ComTec. FAST ComTec assumes no responsibility for modifications made to this software by third parties, or for the use or reliability of this software if used with hardware or software not supplied by FAST ComTec. FAST ComTec makes no other warranty, expressed or implied, as to the merchantability or fitness for an intended purpose of this software.

Software License

You have purchased the license to use this software, not the software itself. Since title to this software remains with FAST ComTec, you may not sell or transfer this software. This license allows you to use this software on only one compatible computer at a time. You must get FAST ComTec's written permission for any exception to this license.

Backup Copy

This software is protected by German Copyright Law and by International Copyright Treaties. You have FAST ComTec's express permission to make one archival copy of this software for backup protection. You may not otherwise copy this software or any part of it for any other purpose.

**Copyright © 1999 FAST ComTec Communication Technology GmbH,
D-82041 Oberhaching, Germany. All rights reserved.**

This manual contains proprietary information; no part of it may be reproduced by any means without prior written permission of FAST ComTec, Grünwalder Weg 28a, D-82041 Oberhaching, Germany. Tel: ++49 89 66518050, FAX: ++49 89 66518040.

The information in this manual describes the hardware and the software as accurately as possible, but is subject to change without notice.

Important Information on Hardware Compatibility

The P7888 Series Multiscalers are PCI Local Bus compliant devices. As such the board contains the configuration space register organization as defined by the PCI Local Bus Specification. Among the functions of the configuration registers is the storage of unique identification values for our devices as well as storage of base address size requirements for correct operation specific to each of our products.

The host computer that our products are installed in is responsible for reading and writing to/from the PCI configuration registers to enable proper operation. This functionality is referred to as 'Plug and Play' (PnP). As such, the host computer PnP BIOS must be capable of automatically identifying a PCI compliant device, determining the system resources required by the device, and assigning the necessary resources to the device. Failure of the host computer to execute any of these operations will prohibit the use of the P7888 Series Multiscalers in such a host computer system.

It has been determined that systems that implement PnP BIOS, and contain only fully compliant PnP boards and drivers, operate properly. However, systems that do not have a PnP BIOS installed, or contain hardware or software drivers, which are not PnP compatible, may not successfully execute PnP initialization. This can render the P7888 Series inoperable. It is beyond the ability of FAST ComTec's hardware or software to force a non-PnP system to operate P7888 Series Multiscalers.

WARNINGS

Damage to the P7886 board, the computer or injury to yourself may result if power is applied during installation.

Static electricity discharges can severely damage the P7886. Use strict antistatic procedures during the installation of the board.

Take care to provide ample airflow around the P7886 board.

Before connecting any input signal on to the discriminator inputs take care not to exceed the maximum differential input voltage of $\pm 3.0\text{ V}$ between the discriminator input and the corresponding threshold voltage (ref. chapter **3.3** and **7.2.1**).

Table of Contents

1. Introduction	1-1
2. Installation Procedure	2-1
2.1. Hard- and Software Requirements	2-1
2.2. Hardware Installation	2-1
2.3. Software Installation	2-2
2.4. Getting Started with a basic measurement	2-3
2.4.1. Connecting the test signals	2-3
2.4.2. Starting the MCDWIN and setup for a measurement	2-4
3. Hardware Description	3-1
3.1. Overview	3-1
3.2. FAST-NIM Signal Inputs	3-2
3.3. +/- 2V Discriminator Inputs	3-3
3.4. SYNC Outputs	3-3
3.5. 'GO'-Line	3-4
3.6. Multi I/O Connector	3-5
3.7. Timebase	3-6
4. Functional Description	4-1
4.1. Introduction	4-1
4.2. Modes of Operation	4-1
4.2.1. Stop-After-Sweep Mode	4-1
4.2.2. Continuous / Wrap-Around Mode	4-1
4.2.3. Sequential Mode	4-1
4.2.4. Start Event Marker	4-1
4.3. START / Trigger Input Logic	4-2
4.4. STOP Input Logic	4-2
4.5. FIFO Concept	4-3
4.6. Measurement Time Window and Acquisition Delay	4-4
4.7. Sweep Counter	4-4
5. Windows Server Program	5-1
5.1. Control Language	5-6
5.2. Controlling the P7886 Windows Server via DDE	5-10
5.2.1. Open Conversation	5-11
5.2.2. DDE Execute	5-11
5.2.3. DDE Request	5-12
5.2.4. Close Conversation	5-13
5.2.5. DDE Conversation with GRAMS/386	5-14
5.3. Controlling the P7886 Windows Server via DLL	5-14
6. MCDWIN Software	6-1
6.1. File Menu	6-2
6.2. Window Menu	6-3
6.3. Region Menu	6-4
6.4. Options Menu	6-7
6.5. Action Menu	6-16

Table of Contents

7. Appendix	7-1
7.1. Performance Characteristics.....	7-1
7.1.1. General.....	7-1
7.1.2. Timebase.....	7-1
7.1.3. Data Throughput	7-1
7.2. Specification.....	7-2
7.2.1. Absolute Maximum Ratings	7-2
7.2.2. Recommended Operating Conditions.....	7-2
7.2.3. Power Requirements.....	7-2
7.2.4. Connectors.....	7-2
7.2.5. Physical	7-4
7.3. Accessories.....	7-4
7.4. Troubleshooting	7-5
7.5. Personal Notes.....	7-6

Table of Figures

Figure 2.1: Extra power supply connector	2-1
Figure 2.2: add-on multi I/O port connector	2-2
Figure 2.3: Basic measurement timing diagram	2-3
Figure 2.4: Basic measurement setup	2-4
Figure 2.5: Bracket mounted signal connectors	2-4
Figure 2.6: P7886 / MCDWIN startup window	2-5
Figure 2.7: P7886 Settings window	2-5
Figure 2.8: Input Threshold window	2-6
Figure 2.9: Axis Parameter window	2-6
Figure 2.10: MCDWIN properly setup	2-7
Figure 2.11: Resulting spectrum of the basic measurement	2-7
Figure 3.1: P7886 PCI board	3-1
Figure 3.2: SMA connectors on the mounting bracket	3-2
Figure 3.3: FAST-NIM input schematic	3-2
Figure 3.4: Discriminator input schematic	3-3
Figure 3.5: FAST-NIM SYNC_1 output schematic	3-4
Figure 3.6: 'GO'-line connector	3-4
Figure 3.7: 'GO'-line logic circuit schematic	3-5
Figure 3.8: Multi I/O port connector pinning	3-5
Figure 3.9: add-on multi I/O connector	3-5
Figure 3.10: Digital I/O port circuit schematic	3-6
Figure 4.1: START input logic schematic	4-2
Figure 4.2: STOP input logic schematic	4-3
Figure 4.3: Two step FIFO concept for highest data throughput	4-3
Figure 5.1: P7886 Server Window	5-1
Figure 5.2: Data Operations dialog	5-2
Figure 5.3: Settings dialog	5-2
Figure 5.4: Input thresholds dialog	5-4
Figure 5.5: System Definition dialog box for a single P7886 card	5-4
Figure 5.6: System Definition dialog box, two P7886 cards	5-5
Figure 5.7: Remote control dialog	5-5
Figure 5.8: Opening the DDE conversation with the P7886 in LabVIEW	5-11
Figure 5.9: Executing a P7886 command from a LabVIEW application	5-12
Figure 5.10: Getting the total number of data with LabVIEW	5-12
Figure 5.11: Getting the data with LabVIEW	5-13
Figure 5.12: Closing the DDE communication in LabVIEW	5-13
Figure 5.13: Control Panel of the demo VI for LabVIEW	5-14

Figure 6.1: MCDWIN main window.....	6-1
Figure 6.2: MCDWIN Map and Isometric display.....	6-2
Figure 6.3: ROI Editing dialog box, left: Single spectra, right: 2D spectra.....	6-5
Figure 6.4: Single Gaussian Peak Fit	6-6
Figure 6.5: Log file Options for the Single Gaussian Peak Fit.....	6-6
Figure 6.6: Colors dialog box	6-7
Figure 6.7: Color Palette dialog box.....	6-8
Figure 6.8: Single View dialog box.....	6-9
Figure 6.9: MAP View dialog box.....	6-9
Figure 6.10: Isometric View dialog box.....	6-10
Figure 6.11: Axis Parameter dialog box.....	6-10
Figure 6.12: Scale Parameters dialog box.....	6-11
Figure 6.13: Calibration dialog box	6-12
Figure 6.14: Comments dialog box	6-13
Figure 6.15: P7886 Settings dialog box.....	6-13
Figure 6.16: Data Operations dialog box	6-14
Figure 6.17: System Definition dialog box	6-14
Figure 6.18: Tool Bar dialog box.....	6-15
Figure 6.19: Function keys dialog box	6-15

1. Introduction

The P7886 PCI board is one of the fastest commercially available multiple event time digitizers. It can be used as an ultra fast Multiscaler/TOF system in Time-of-Flight Mass-Spectrometry and time-resolved Single Photon Counting.

The P7886 is capable of accepting one event (stop pulse) in every time bin. Burst/peak count rates of up to 2 GHz (1 GHz @ S-version¹, 0.5 GHz = 500MHz @ E-version²) can be handled with no deadtime between timebins. A proprietary input logic securely prevents double counting.

The dynamic range of up to 37 (36 @S, 35 @E) bit enables sweeps for an incredible 68.7 seconds with a time resolution of 500 ps (1 ns @S, 2 ns @E). A crystal stabilized PLL oscillator assures a resolution of typically 400 ps FWHM at a full scale time range of 1 ms (measured in the last time bin of 2,000,000 time bins (1,000,000 @S, 500,000 @E) and 30 minutes acquisition time). An optional available oven stabilized oscillator further improves long-term and temperature stability.

A two step FIFO memory concept enables for ultra high event rate capability. Full 2 GHz (1 GHz @S, 500 MHz @E) bursts can be buffered for at least 4 μ s. The first 255 deep multi event FIFO buffers incoming events at a maximum countrate of 2 GHz (1 GHz @S, 500 MHz @E). A second 16k deep FIFO is filled at over 18 MHz and buffers the subsequent data transfer over the PCI bus. Data reduction is performed by recording interesting, i.e. inside a preselected time window arriving stop events only.

For experiments requiring repetitive sweeps the spectral data obtained from each sweep can be summed in the PC enabling extremely high sweep repetition rates. A presettable 32 bit sweep counter enables for exact normalization calculations.

The logical combination of the FAST-NIM and \pm 2V discriminator inputs allows for fast gating of START and STOP signals.

An open-drain 'GO'-line (compatible to other products of FAST ComTec) allows for overall experiment synchronization.

Two software configurable SYNC outputs provide synchronization and triggering of external devices or experiment monitoring.

A versatile 8 bit digital I/O port may further satisfy your experimental needs.

The P7886 is a fully digital design with "state-of-the-art" components offering excellent performance and reliability.

The high-performance hardware is matched by sophisticated software delivered with each P7886. MCDWIN - the MS-WINDOWS based operating software - provides a powerful graphical user interface for setup, data transfer and spectral data display.

Some of MCDWIN's features are high-resolution graphics displays with zoom, linear and logarithmic (auto)scaling, grids, ROIs, Gaussian fit, calibration using diverse formulas and FWHM³ calculations. Macro generation using the powerful command language allows task oriented batch processing and self-running experiments.

"C"-Libraries are available for controlling functions from the user's application program. A DLL (Dynamic Link Library) is available for operation in a Laboratory Automation environment.

¹ @S will further indicate the data for the 1 GHz P7886S

² @E will further indicate the data for the 500 MHz P7886E

³ Full width at half maximum

2. Installation Procedure

2.1. Hard- and Software Requirements

The P7886 requires an IBM AT or compatible computer with an i486, Pentium or higher processor and an available PCI slot.

A Pentium II or higher processor and at least 64MB of memory are recommended.

A Microsoft WINDOWS NT 4.0 or higher operating system must be installed.

2.2. Hardware Installation

Turn off the power to your computer system and remove the line cord. Discharge your body from any static electricity by touching a grounded surface – e.g. the metal surface of the power supply – before performing any further hardware procedure.

FAST ComTec assumes no liability for any damage, caused directly or indirectly, by improper installation of any components by unqualified service personnel. If you do not feel comfortable performing the installation, consult a qualified technician.

WARNING

Damage to the P7886 board, the computer or injury to yourself may result if power is applied during installation.

Static electricity discharges can severely damage the P7886. Use strict antistatic procedures during the installation of the board.

Open the cover of the computer case and insert the P7886 PCI board in an unused PCI slot. You might first have to remove the cover from the rear of the PCI expansion slot you selected. After the board is carefully seated in the PCI slot, make sure you fasten the board with a screw to the mounting bracket.

WARNING

Take care to provide ample airflow around the P7886 board.

While all the power may be derived over the PCI bus connector the large current from the +12 V supply, however strongly suggests to use the supplied extra power cable to draw power from the PC's power supply directly.

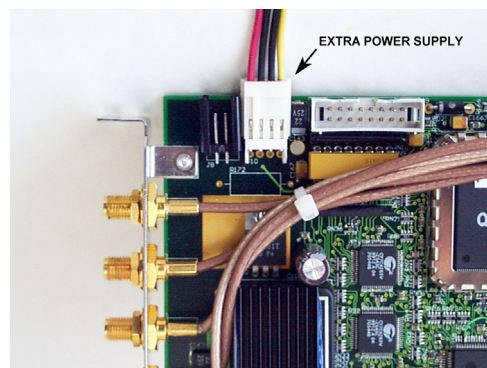

Figure 2.1: Extra power supply connector

For this, connect the small 3.5" floppy type power connector of the delivered floppy Y-cable to the 'EXTRA POWER SUPPLY' connector on the P7886 (ref. Figure 2.1) and to your PC's power supply. The connectors are polarized so a false connection cannot easily be made (red = +5 V is left, yellow = +12 V is right).

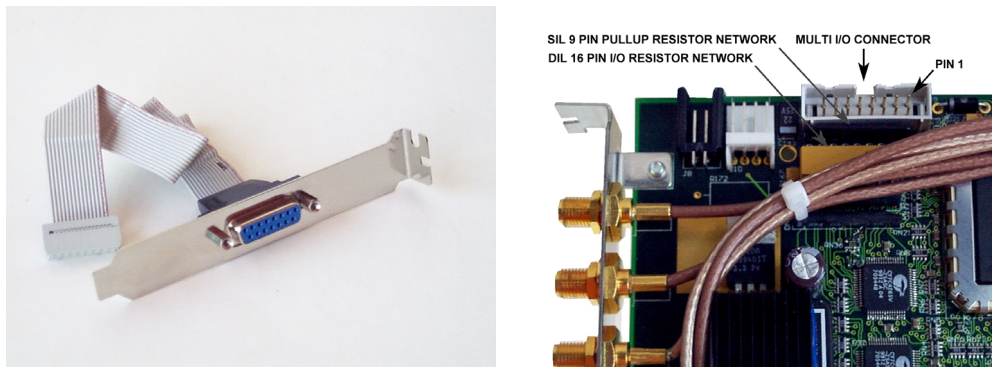

Figure 2.2: add-on multi I/O port connector

Now install the add-on multi I/O port connector. In some computer cases special fittings are available for some types of D-SUB connectors. These are particularly useful to save slots for additional plug in boards. Otherwise mount the housing bracket with the 15-pin D-SUB connector in another available slot of your computer. Plug in the 16-pin socket connector (at the end of the ribbon cable) into the 16 pin four-walled header on the P7886 PCI board.

WARNING

Before connecting any input signal on to the discriminator inputs take care not to exceed the maximum differential input voltage of $\pm 3.0\text{ V}$ between the discriminator input and the corresponding threshold voltage (ref. chapter 3.3 and 7.2.1).

2.3. Software Installation

If you are using Windows 98 or Windows 2000, the hardware manager will recognize the PCI card as a new hardware the first time after power on with the PCI card mounted, and will ask for a driver. Please insert then the installation disk and specify A:\WDMDRV as the driver location.

To install the P7886 software on your hard disk insert the P7886 disk into drive A. Log to drive A: by typing from a DOS box or searching with the explorer

```
C :> A: <RETURN>
```

and start the installation batch file by typing (or double clicking)

```
A :> INSTALL <RETURN>
```

A directory called C:\P7886 is created on the hard disk and all P7886 and MCDWIN files are transferred to this directory. Drive C: is taken as default drive and \P7886 as default directory. It is not mandatory that the P7886 operating software is located in this directory. After the installation is completed you may copy the files to any other directory.

When using Windows NT 4.0, please install then the driver from the NTDRIVER subdirectory on drive A and reboot.

```
A :> CD NTDRIVER <RETURN>
A :NTDRIVER> INSTALL <RETURN>
```

Use the Explorer to find the icons of MCDWIN.EXE and P7886.EXE (look in C:\P7886) and drag them onto the Desktop keeping the right mouse button pressed. P7886.EXE is the P7886 Hardware Server program. This program will automatically call the MCDWIN.EXE program when it is executed. The P7886 Server program controls the P7886 board but provides no graphics

display capability by itself. By using the MCDWIN program, the user has complete control of the P7886 along with the MCDWIN display capabilities.

If you have more than one P7886 modules installed, edit the line devices=1 and enter the number of modules. The frequency of the PLL in units of Hz has to be defined in the W7886.INI file by a line like `pllfreq=2e9` (`pllfreq=1e9 @S`, `pllfreq=5e8 @E`).

To run the P7886 program, simply double click on the “P7886 Server Program” icon.

2.4. Getting Started with a basic measurement

To ease getting familiar with the use of the P7886 we will now setup a basic measurement. We use a simple TTL signal generator to supply START and STOP signals.

We want to measure the arrival time of multiple STOP events in a time range of 4 μs after a START (Trigger) pulse. The measurement should run for exactly 1,000,000 sweeps (scans, shots) until it ends. The resulting spectrum is suggested to look like a garden fence with peaks every 100 ns or 200 (100 @S, 50 @E) time bins.

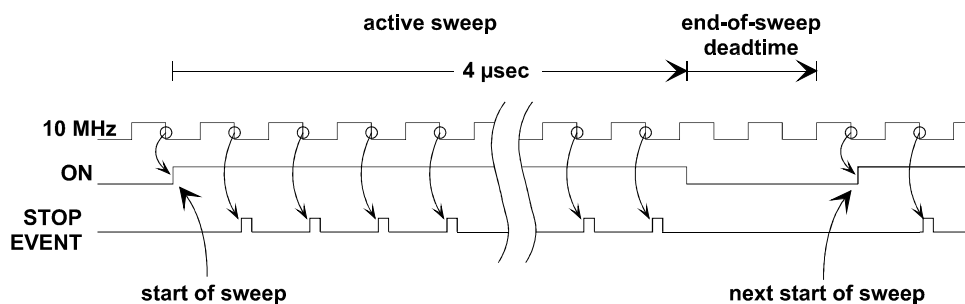

Figure 2.3: Basic measurement timing diagram

First let's setup up the wire connections to the board and then start the software to run the measurement.

2.4.1. Connecting the test signals

The generator must be able to drive two 50 Ω inputs to some 1 Volts and should not exceed 2.5 V as not to exceed the absolute maximum ratings of the discriminator inputs. For this, a 50 Ω power splitter divides the 10 MHz TTL signal into two branches. The two output signals of the power splitter are connected to the ± 2 V discriminator START and STOP inputs on the PCI bracket (ref. Figure 2.5).

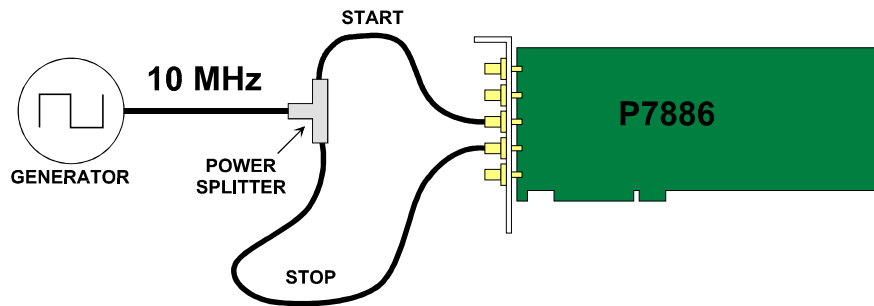

Figure 2.4: Basic measurement setup

WARNING

Before connecting any input signal on to the discriminator inputs take care not to exceed the maximum differential input voltage of $\pm 3.0\text{ V}$ between the discriminator input and the corresponding threshold voltage (ref. chapter 3.3 and 7.2.1).

On power up the threshold levels are initially set / reset to 0 V.



Figure 2.5: Bracket mounted signal connectors

2.4.2. Starting the MCDWIN and setup for a measurement

Next step is to start the P7886 software by double clicking the corresponding icon. This will automatically start the MCDWIN program. On startup the P7886 Server is iconized and one does not have to worry about it since all hardware settings are also accessible from the MCDWIN program which actually is the graphical user interface and which will appear now on your screen (ref. Figure 2.6).

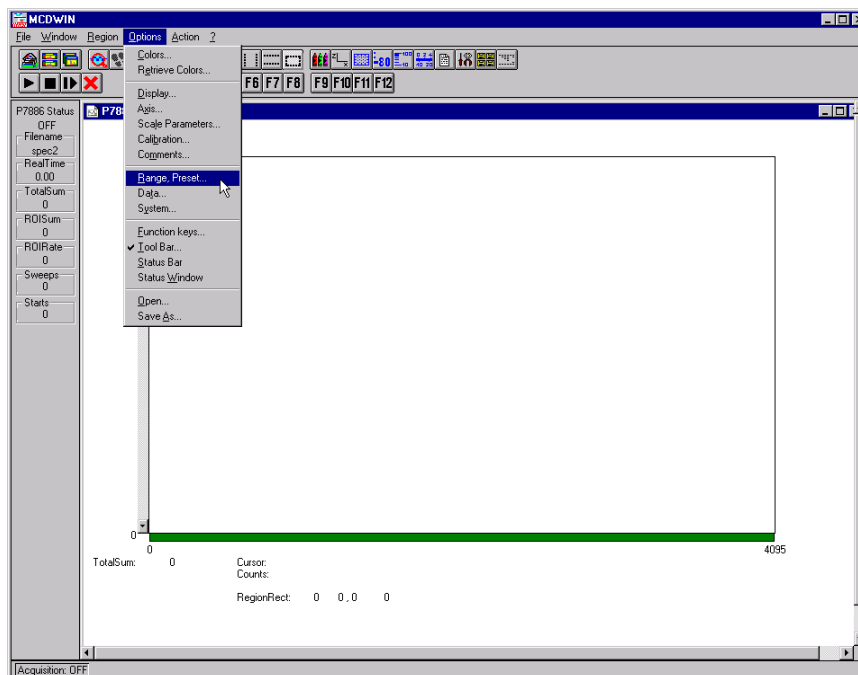

Figure 2.6: P7886 / MCDWIN startup window

Now we first have to setup the P7886. Click on **Options – Range, Preset ...** to find the P7886 Settings window pop up. Set the Range to 8000 (4000 @S, 2000 @E) which corresponds to the desired 4 μ s time range. Enable the sweep preset and type in the number of sweeps as 1,000,000 (ref. Figure 2.7). Then click on **Inputs** to select the desired input threshold levels.

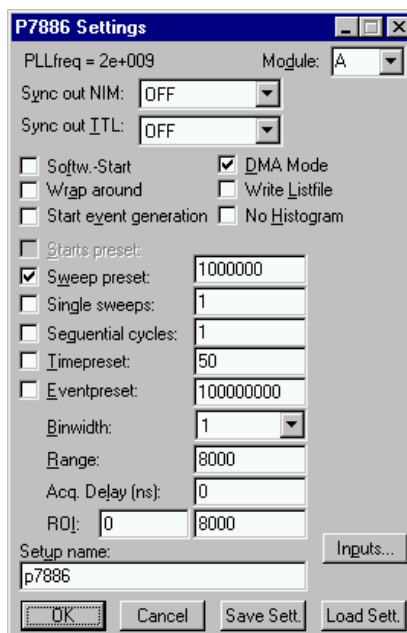

Figure 2.7: P7886 Settings window

Select the ± 2 V discriminator inputs and deselect the **NIM** inputs which will actually set the FAST-NIM threshold levels to a slightly positive voltage. Thus, without a signal applied the FAST-NIM inputs will not influence the measurement. The discriminator inputs are set to Slow NIM which

actually sets the threshold voltage to 1.0 V (ref. Figure 2.8). Now click OK to get back to the P7886 Settings window. Again click OK.

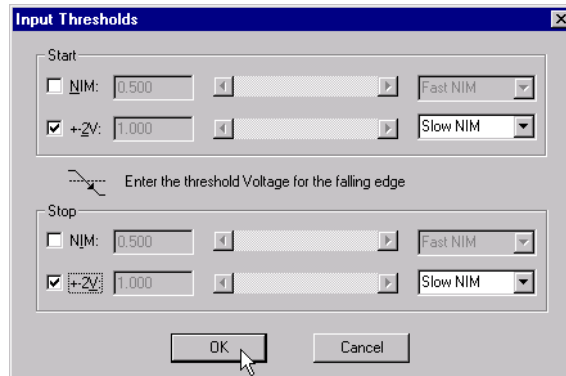

Figure 2.8: Input Threshold window

Now lets change the display to have a grid and the axis numbered. Click on Options – Axis.... Enable the grid and the axis ticks (ref. Figure 2.9). Then click OK.

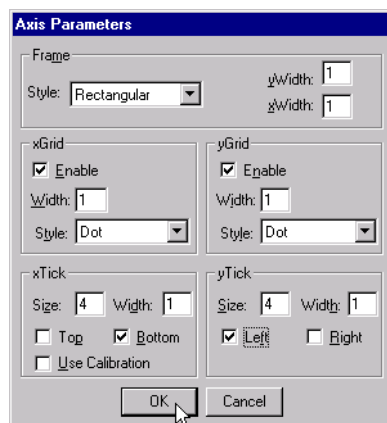

Figure 2.9: Axis Parameter window

The hardware is initialized properly now and also the display should look as in Figure 2.10. To start the measurement now click on the Start button.

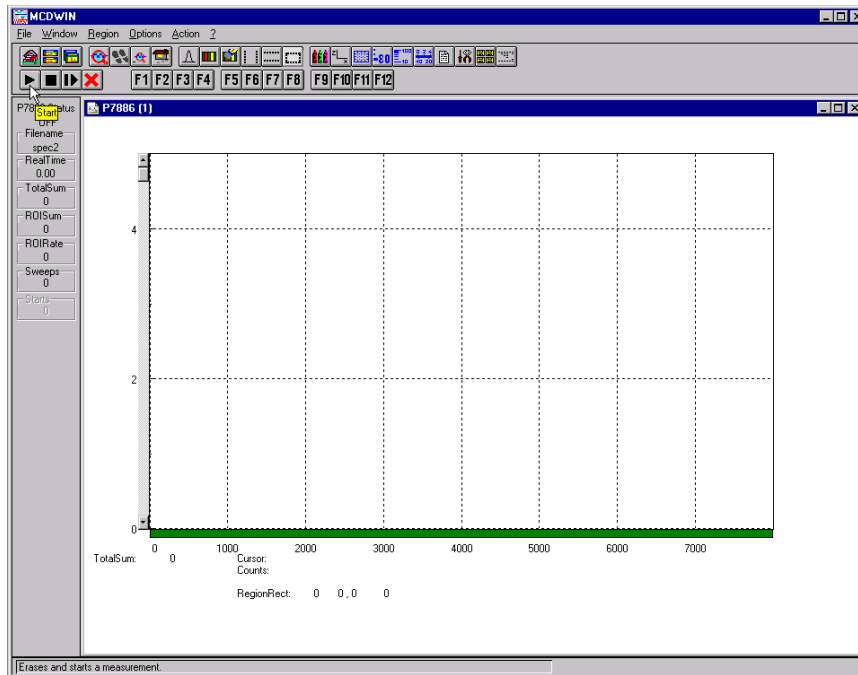

Figure 2.10: MCDWIN properly setup

The measurement will begin to run and end when 1,000,000 sweeps are done. The resulting spectrum should look as in Figure 2.11. The peaks are separated by 200 channels (100 @S, 50 @E) or 100 ns. The sweep counter shows that exactly 1,000,000 sweeps have been acquired.

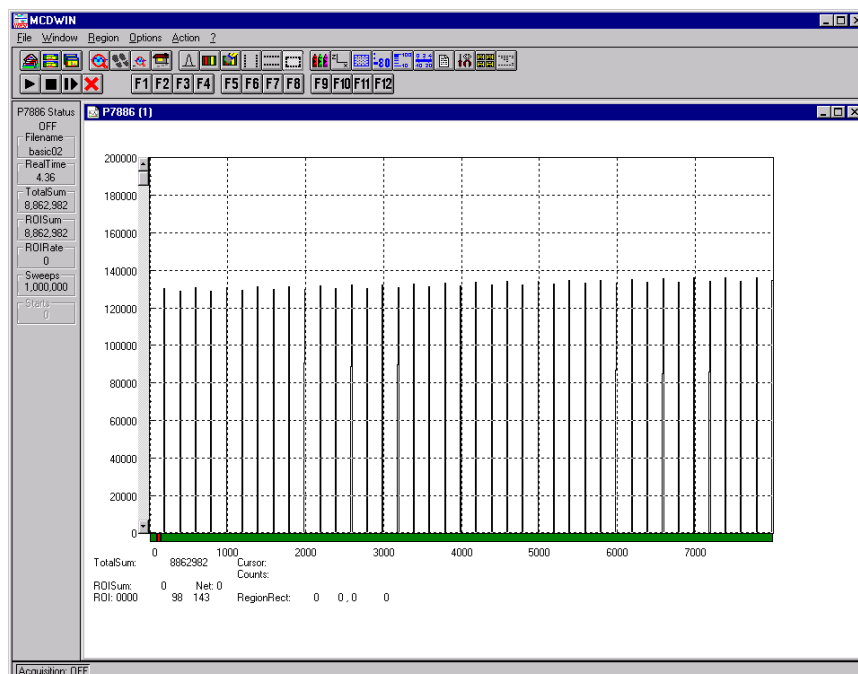

Figure 2.11: Resulting spectrum of the basic measurement

3. Hardware Description

3.1. Overview

The P7886 is a full size PCI PC board with bus master capabilities. All settings are software selectable. No jumper, switch, etc. configurations necessary. It is able to measure multiple events with a time resolution of 500 ps (1 ns @S, 2 ns @E) at an incredible low pulse pair follow time of also 500 ps (1 ns @S, 2 ns @E). No deadtime between the time bins and secure prevention of double counting is established by the sophisticated input logic circuitry.

The concept of a two step onboard FIFO with an ultra fast 255 deep multi event FIFO and a second 16k deep FIFO allows for unprecedented burst and average count rates.

Additional features are two onboard discriminators logically combined with the two FAST-NIM inputs (ref. chapters 4.3 and 4.4). This enables for either high speed gating of the inputs or adjustment to non FAST-NIM input signals.

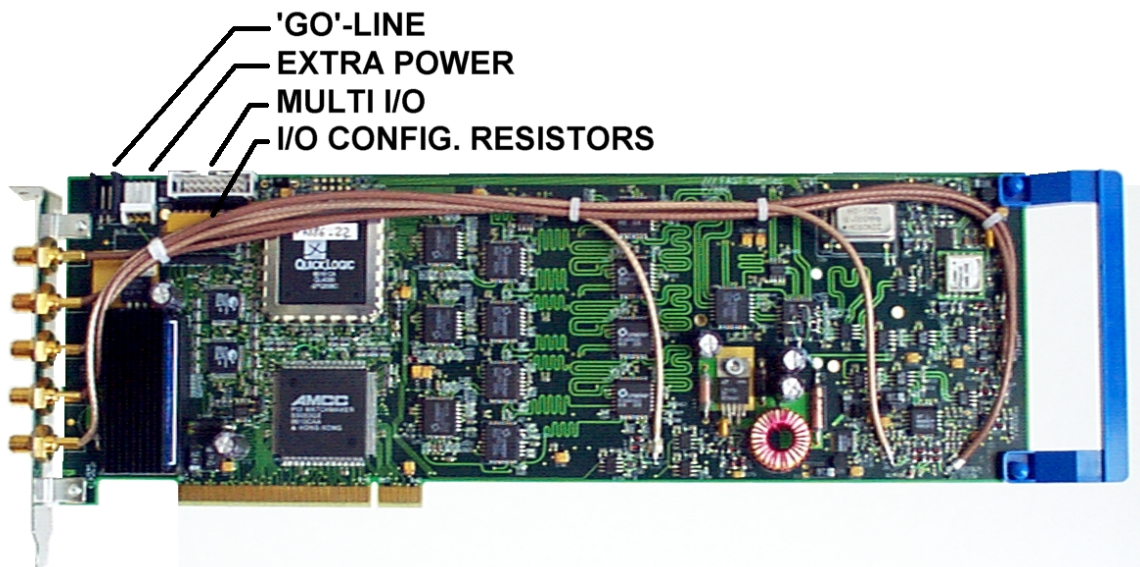

Figure 3.1: P7886 PCI board

Besides, two SYNC outputs with a large variety of output signal options (all software selectable) and the 'GO'-line (compatible to other FAST products) allow for easy synchronization or triggering of other measurement equipment.

Furthermore a versatile, user configurable 8 bit digital I/O port allows for a whole bunch of experimental control, monitor or whatsoever other tasks.

3.2. FAST-NIM Signal Inputs

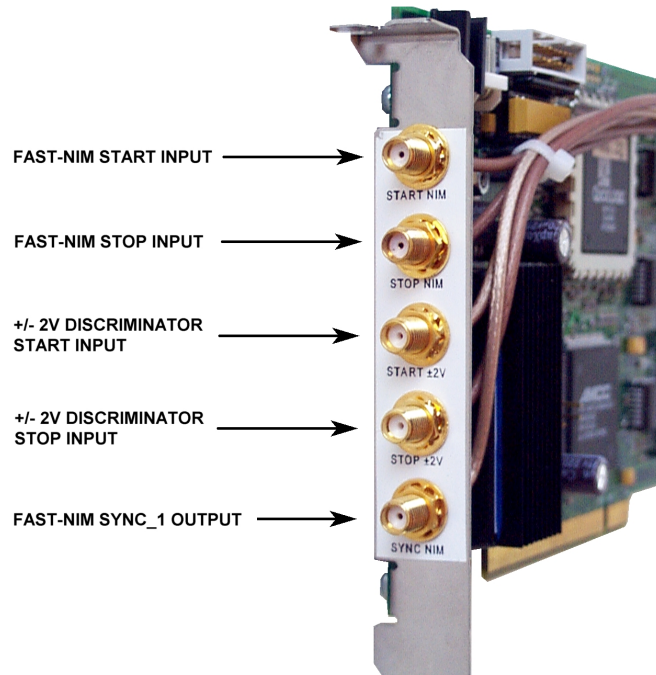

Figure 3.2: SMA connectors on the mounting bracket

For highest accuracy and data rate requirements use the FAST-NIM inputs located at the PCI board mounting bracket. These inputs accept FAST-NIM pulses (0/-0.7 V, 14 mA, $Z_{in} = 50 \Omega$). The connectors are SMA types. The threshold level is fine tunable in a range of $-0.25 \dots -0.80$ V and defaults to -0.4 V.

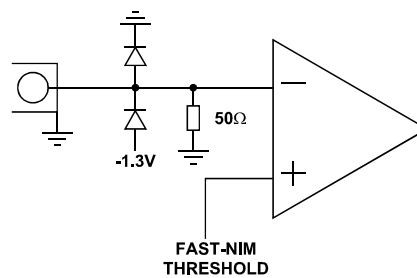

Figure 3.3: FAST-NIM input schematic

3.3. +/- 2V Discriminator Inputs

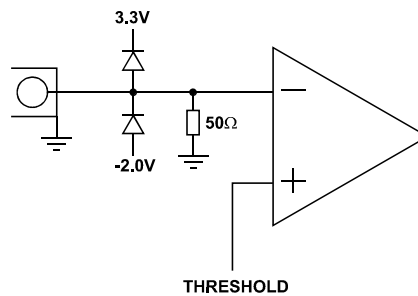

Figure 3.4: Discriminator input schematic

The discriminator inputs (ref. Figure 3.2) accept input signals in a range of ± 2 V. The input impedance is $50\ \Omega$. The inputs are falling edge sensitive. The threshold level is software tunable in a range of ± 1.5 V.

WARNING

Take care not to exceed the maximum differential input voltage of ± 3.0 V between the discriminator input and the threshold voltage (ref. chapter 7.2.1).

3.4. SYNC Outputs

The SYNC outputs provide a large variety of output signals for a lot of synchronizing, triggering, monitoring or whatever application. The selectable output signals are:

- OFF: indicates a running sweep when '0'
- FIRST: pulsed high when the acquisition delay has elapsed after a start
- LAST: pulsed high when the acquisition time range ends (\cong end-of-sweep)
- FIFO1_FULL: the ultra fast 255 deep FIFO is full
- FIFO2_FULL: the large 16k deep FIFO is full
- COUNT[0]: $16\ \text{ns} = 2^0 \times 16\ \text{ns}$ periodic timer signal while a sweep is running
- COUNT[1]: $32\ \text{ns} = 2^1 \times 16\ \text{ns}$ periodic timer signal while a sweep is running
- COUNT[2]: $64\ \text{ns} = 2^2 \times 16\ \text{ns}$ periodic timer signal while a sweep is running
...
- COUNT[26]: $1.074\ \text{s} = 2^{26} \times 16\ \text{ns}$ periodic timer signal while a sweep is running
- SWEEP[0]: bit 0 (LSB) of the sweep counter
- SWEEP[1]: bit 1 of the sweep counter
- SWEEP[2]: bit 2 of the sweep counter
...
- SWEEP[31]: bit 31 (MSB) of the sweep counter

All these signals may be output on the FAST-NIM SYNC_1 output on the mounting bracket and on the TTL SYNC_2 output on the multi I/O port connector as well.

NOTE:

The initial states of the 'SWEEP' output bits depend on the preset value of the corresponding counter. The sweep counter is a 32 bit up-counter. In case of a preset it is set to ($FFFFFFF_{\text{hex}} - \text{'preset_value'}$) and runs until $FFFFFFF_{\text{hex}}$ is reached. When no preset is used the sweep counter is initially set to all zero.

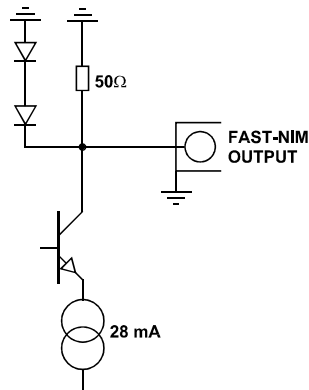

Figure 3.5: FAST-NIM SYNC_1 output schematic

The FAST-NIM SYNC output supplies standard FAST-NIM (0...-0.7 V / 14 mA) signals into a 50 Ω load. The output impedance also is 50 Ω . For FAST-NIM signals a logical 'TRUE' corresponds to a low voltage (-0.7 V), e.g. while a sweep is running 'OFF' will result in 0 V (= 'FALSE') output.

3.5. 'GO'-Line

The system-wide open-drain 'GO' line enables any connected device to start and stop all participating measurement equipment simultaneously. This allows for easy synchronization of electronic devices previously often not possible.

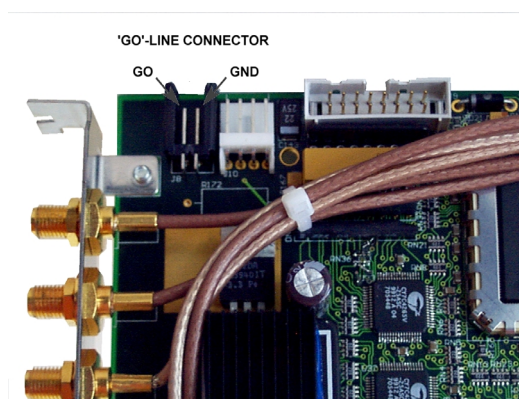

Figure 3.6: 'GO'-line connector

The 'GO' line is a system-wide open-drain wired-AND signal that can start and stop a measurement. This line is also available on the Multi I/O port connector (ref Figure 3.8). The 'GO'-line may be enabled, disabled, set and reset by the software.

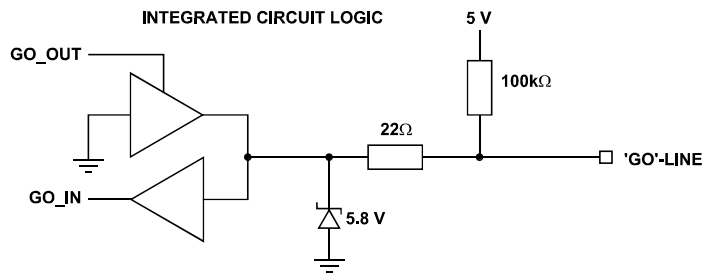

Figure 3.7: 'GO'-line logic circuit schematic

When watching of the 'GO'-line is enabled a low voltage will halt the measurement. When output to the 'GO'-line is enabled starting a measurement will release (high impedance output) the 'GO'-line whereas a halt of the measurement will pull down the 'GO'-line to a low state. Since it is an open drain output wired AND connection with other devices is possible.

3.6. Multi I/O Connector

A very versatile 8 bit digital I/O port is implemented on the 16 pin four-walled header. The supplied ribbon cable connects to a 15-pin female D-SUB connector fixed on a mounting bracket.

Since the resistors are socket mounted (ref. Figure 3.9) they can be easily user configured in a most flexible way.

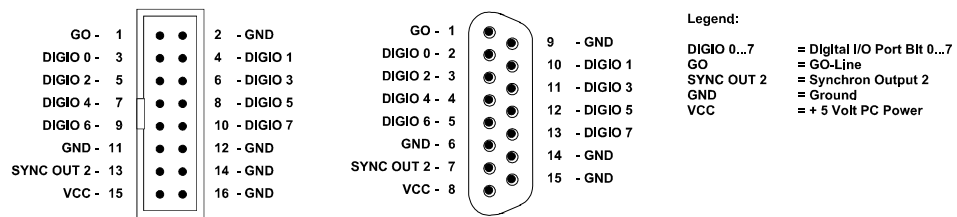

Figure 3.8: Multi I/O port connector pinning

This I/O port is fully software controllable and each single (1-bit) port is individually configurable. It might be used for external alert signals, sample changer control, status inputs / outputs etc.

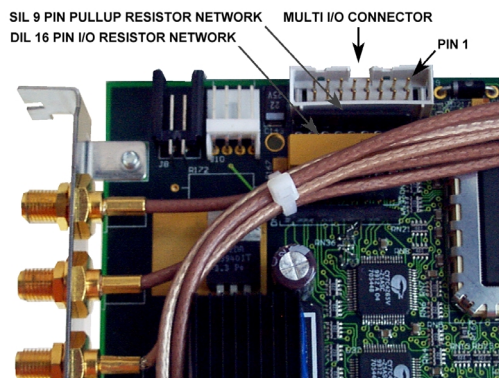

Figure 3.9: add-on multi I/O connector

As can be seen from Figure 3.10 each bit of the digital I/O port might be configured as input only (tri-stated output), pull-up (open drain) or driver output (small R I/O) with readback capability. Wired-OR / AND connections are also feasible.

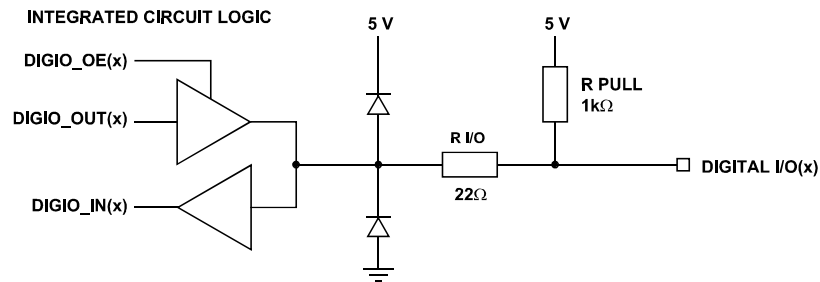

Figure 3.10: Digital I/O port circuit schematic

3.7. Timebase

To derive the outstanding temperature and long-term stability the P7886 is equipped with an onboard crystal stabilized PLL (phase locked loop) 2 GHz (1 GHz @S, 500 MHz @E) synthesizer oscillator. It is fine tunable by the software in a range of 1.95 – 2.15 GHz (0.975 – 1.075 GHz @S, 488 – 537 MHz @E).

For highest stability requirements an optional oven stabilized crystal oscillator is available.

The ovenized option is particularly recommended for longer sweep ranges or long-term measurements. When figuring that a measurement at say 10 ms after the start has a dynamic range of 20 million channels a low timebase drift of only 1 ppm will result in a 20(!) channel drift at the end of the 10 ms range.

4. Functional Description

4.1. Introduction

The P7886 measures the arrival time of STOP input events relative to a previous START signal. The resolution or time bin width is 500 ps (1 ns @S, 2 ns @E). The full dynamic range is 37 bit (36 bit @S, 35 bit @E) of which the lower 32 bit (31 bit @E) are transferred into the PC. The higher order bits are per se known by the system setup. The 27 bits 5...31 of the timer are also accessible via the SYNC outputs (COUNT[0...26], ref. chapter 3.4). The measured data is transferred into the PC memory in list mode, i.e. as they are acquired.

4.2. Modes of Operation

4.2.1. Stop-After-Sweep Mode

This might be the most usual mode of operation. When the P7886 is armed it waits for a START input signal. When one occurs the sweep is started / triggered meaning the time starts to count. Now the arrival times of the STOP input signals relative to the start are acquired. When the selected measurement time range has elapsed the sweep and so the data acquisition ends. After a short (≤ 200 ns) end-of-sweep deadtime the P7886 is ready for a new start and begins a new sweep as soon as the next START signal arrives.

4.2.2. Continuous / Wrap-Around Mode

This mode features absolutely no end-of-sweep deadtime. It is applicable to cyclic experiments allowing the P7886 to control the whole measurement. Once started, e.g. by the software or a single start signal, the P7886 timer runs continuously wrapping around at the end of its 37 bit (36 bit @S, 35 bit @E) range. When one of the timer bits controls / triggers the external experimental setup via the SYNC outputs you per se know that the higher data bits can be discarded.

The lowest order bit accessible (ref. chapter 3.4) is $2^5 \times 500$ ps = 16 ns (= COUNT[0]). Thus, the minimum cycle time is 32 ns corresponding to 'COUNT[0]' which toggles every 16 ns giving a 32 ns period.

Example:

Cyclic measurement with $2^8 \times 32$ ns = 8192 ns period. Trigger the external devices when 'COUNT[8]' toggles from 'TRUE' to 'FALSE'. Thus, the lower $6 + 8 = 14$ bit (13 bit @S, 12 bit @E) of the acquired event data may be histogrammed giving a 16kchannel (8k @S, 4k @E) spectrum.

4.2.3. Sequential Mode

Like the stop-after-sweep mode but with a preselected number of sweeps. When the sweep preset is reached the FIFO is emptied, the corresponding spectrum closed and a new sequence with the same number of sweeps is started. Thus, the timely development of a histogrammed distribution may be watched.

4.2.4. Start Event Marker

For e.g. off-line or replay analysis of an experiment start markers may be inserted into the list mode data stream. This also enables to keep the full correlation of start and subsequent stop events. So one always knows what stop events belong to a special start event.

Extreme care should be taken not to fill up the fast 255 deep FIFO as this might lead to the loss of data integrity when a start event marker is missed due to a full FIFO. The detection of a filled FIFO is possible via some register flags and the SYNC outputs.

4.3. START / Trigger Input Logic

The presence of two inputs for triggering a sweep allows for easy very high speed gating of the measurement. As can be seen from Figure 4.1 both of the inputs are first inverted through an input receiver / discriminator circuit. Thus, a falling edge of the input signal is converted to a rising edge of the internal logic signal. Then, the signals are combined in a logical AND gate and fed into the rising-edge sensitive clock input of a flip-flop. A start / trigger of a sweep will occur when the flip-flop sees this rising edge.

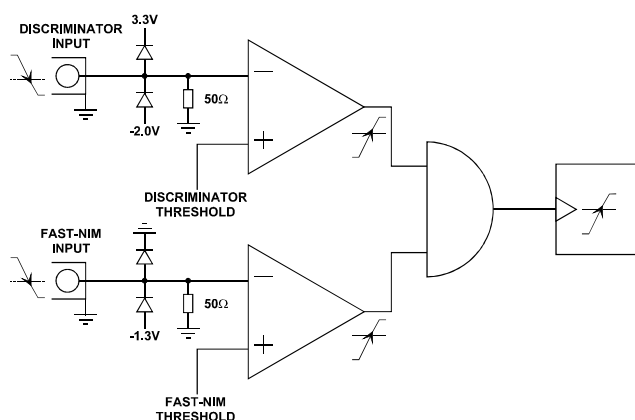

Figure 4.1: START input logic schematic

For gating the starts both inputs can be used. A start of sweep will only be generated when the one input is 'LOW' while a falling edge on the other input occurs. If one input stays above the corresponding threshold level starts are prohibited.

NOTE:

When gating use narrow pulses for the start signal to prevent the generation of false starts when the gate signal goes 'LOW'.

No signal should be connected to an unused input. '

When only one input is used, as might be the regular case, the software switches off the other input.

4.4. STOP Input Logic

As with the start input the presence of two inputs also for the generation of the stop events allows for easy very high speed gating of the acquired stop events. As can be seen from Figure 4.2 both of the inputs are first inverted through an input receiver / discriminator circuit. Thus, a falling edge of the input signal is converted to a rising edge of the internal logic signal. Then, the signals are combined in a logical AND gate and fed into the rising-edge sensitive clock input of a flip-flop. A stop event will be detected when the flip-flop sees this rising edge which corresponds to the falling edge at the input connector.

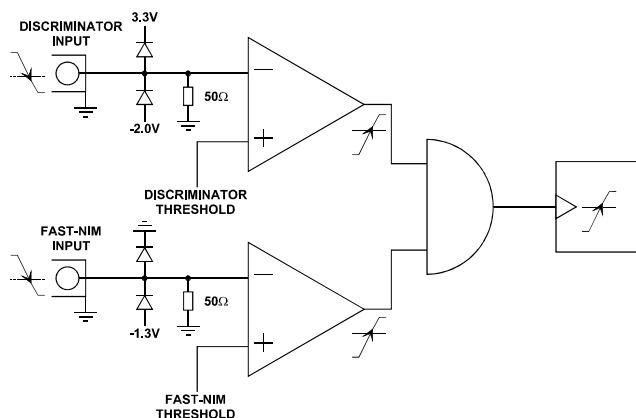

Figure 4.2: STOP input logic schematic

For gating the stop events both inputs can be used. A stop event will only be detected when the one input is 'LOW' while a falling edge on the other input occurs. If one input stays above the corresponding threshold level any event detection is prohibited.

NOTE:

When gating use narrow pulses for the stop events to prevent generation of false stops when the gate signal goes 'LOW'.

No signal should be connected to an unused input.

When only one input is used, as might be the regular case, the software switches off the other input.

4.5. FIFO Concept

A two step FIFO concept is used to get the ultra high burst count rate of 2 GHz (1 GHz @S, 500 MHz @E) while also providing a large average or sustained event rate.

The detected stop events are fed into a 255 deep ultra fast multi event First-In-First-Out memory. A sophisticated input logic allows to buffer stop events every 500 ps (1 ns @S, 2 ns @E) for at least 4 μs which corresponds to a burst count rate of 2 GHz (1 GHz @S, 500 MHz @E) for a whole 8k (4k @S, 2k @E) spectrum (!). As a matter of fact each of the 255 FIFO words contains a period of 16 ns regardless of the number of stop events. This data is then transferred to the second 16k deep FIFO memory. The depth of this second FIFO assures that high speed DMA data transfer over the PCI bus is feasible without easily losing data by a filled up FIFO.

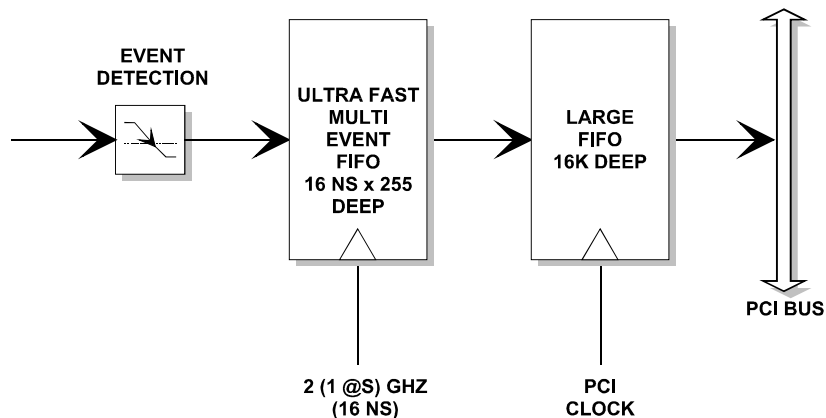

Figure 4.3: Two step FIFO concept for highest data throughput

When an experiment requires to be absolutely sure not to miss any single stop event the condition of an occasionally filled FIFO is detectable via internal register flags and the SYNC outputs. Thus, the experimental setup might be changed to prevent e.g. shadow effects or wrong normalization that might occur from such a situation.

4.6. Measurement Time Window and Acquisition Delay

The time window in which stop events are acquired is programmable over a wide range. The begin (delay after the Start/Trigger) and end of the window is fully programmable. This enables to detect even late events with large input count rates. This is due to the data reduction executed. The fact is that all data, that occur outside the selected time window, are discarded.

An acquisition delay, programmable in increments of 16 ns, begins data acquisition only when the selected time after the corresponding START signal has elapsed. Then data is sampled for the selected time range. All events occurring before the acquisition offset time has elapsed are discarded and do not contribute to the burst and average data rate.

The theoretical limit of the measurement window is 2 seconds $\cong 2^{32}$ time bins (4 sec @S, 2 sec $\cong 2^{31}$ bins @E) which can be layed inside any 2 second ($\cong 2^{32}$ bin, $\cong 2^{31}$ bin @E) (4 sec @S) block in the 68 sec ($\cong 2^{37}$ bins, 2^{36} bins @S, 2^{35} bins @E) full dynamic range. The maximum acquisition delay is $(2^{37} - 2^{32}) \times 16 \text{ ns} \cong 66 \text{ sec}$ (64 s @S).

Example:

Average STOP data rate of 100 MHz. Interesting time window is 1 μs at 1 ms after the START / TRIGGER signal:

In a time range of 1 ms the 100 MHz input rate would result in 100,000 STOP events which would cause data loss due to filled FIFOs. When programming an acquisition offset of 1 ms and a 1 μs measurement time window the resulting number of events per sweep is only 100. Thus, no data loss at all will occur. And even with highest speed sweep repetition rate an average data rate of only some 1000 sweeps/sec \times 100 events/sweep = 100,000 events/sec has to be stored.

4.7. Sweep Counter

A presettable 32 bit sweep counter is incremented at every start of a sweep. In fact the sweep counter counts the real start of a new sweep rather than the completion of sweeps. When the preset is enabled and the preselected number of sweeps have occurred further start of a sweep is disabled.

The individual bits may be output and watched on the SYNC outputs (ref. Chapter 3.4). They are particularly useful when some experiment should be periodically changed after a fixed number of sweeps.

5. Windows Server Program

The window of the P7886 server program is shown here. It enables the full control of the P7886 card to perform measurements and save data. This program has no own spectra display, but it provides - via a DLL („dynamic link library“) - access to all functions, parameters and data. The server can be completely controlled from the MCDWIN software that provides all necessary graphic displays.

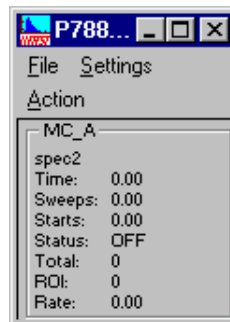

Figure 5.1: P7886 Server Window

At program start the configuration files P7886.INI and P7886A.INF are loaded. Up to 4 P7886 modules can be used. Specify the number of modules in the P7886.INI file with a line `devices=n`. You can also specify more than one module if you have only physical module. The software runs then for the not physical modules in demo mode and it is possible to load spectra and compare them in MCDWIN.

The frequency of the PLL in units of Hz has to be defined in the P7886.INI file by a line like `pllfreq=2e9` or `pllfreq=1e9` for a P7886S. This is also a command of the control language. Instead of the frequency also the divider can be set by a control command `plldiv=400000`. The PLL frequency for the PLL oscillator is calculated from the divider by a formula

$$\text{pllfreq} = \text{plldiv} * 5000. \text{ (P7886S: } \text{plldiv} * 2500).$$

The file P7886A.INF (P7886B.inf... for more modules) contains the default settings. Instead of this .INF file any other setup file can be used if its name without the appendix 'A.INF' is used as command line parameter (e.g. `P7886 TEST` to load TESTA.INF).

The server program is normally shown as an icon. After double clicking the icon the upper left portion is opened to show the status window. Using the „**Start**“ menu item a measurement can be started. In the status window every second the acquired events, the counting rate and the time are shown. Clicking the „**Halt**“ menu item the measurement is stopped and via „**Continue**“ proceeded.

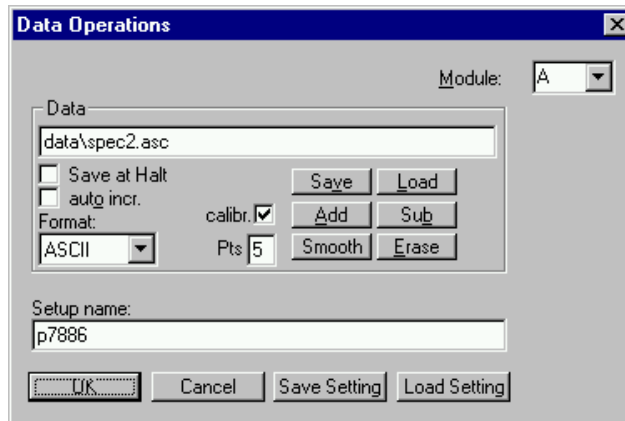

Figure 5.2: Data Operations dialog

The Data... item in the File menu opens the Data Operations dialog box. Mark the checkbox „**Save at Halt**“ to write a spectrum- and a configuration file at the stop of a measurement. The filename can be entered. If the checkbox „**auto incr.**“ is marked, a 3-digit number is appended to the filename that is automatically incremented with each saving. The format of the data file can be ASCII or binary (extension .ASC or .DAT). Click on „**Save**“ to write a data- and configuration file of the actual data with the specified name. By pressing „**Load**“ previously stored data can be loaded or a **control file** (extension .CTL) executed. With „**Add**“ or „**Sub**“ a stored spectrum can be added to or subtracted from the present data. Check the checkbox „**calib.**“ to enforce using a calibration and shift the data to be added according to the calibration. The „**Smooth**“ button performs a n-point smoothing of the spectrum data. The number of points to average can be set with the „**Pts**“ edit field between 2 and 21. „**Erase**“ clears the spectrum.

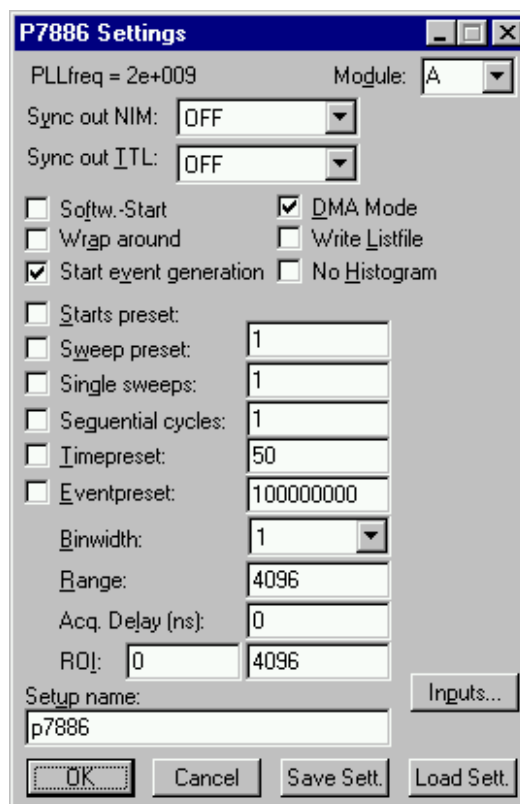

Figure 5.3: Settings dialog

The Hardware... item in the Settings dialog opens the P7886 Settings dialog box. The mode of the measurement can be **Wrap around** if the corresponding checkbox is crossed, or Sweep mode. In Sweep mode usually via an external start signal a sweep is started, after completion the next sweep starts with the next start pulse. In the **Wrap around** mode the time-counter counts endless. If **Softw. Start** is marked, no start signal is necessary. The time-counter is masked corresponding to the chosen range and the higher bits are not evaluated. The signal for the synchronisation of the experiment can be obtained from one of the two Sync Out outputs.

Via the **Sync out** - combo boxes you can specify to get at the Sync Out output a pulse at the **OFF** state (i.e. no sweep is running), **FIRST** when the acquisition in a sweep starts, **LAST** when it stops, when **FIFO1_FULL** or **FIFO2_FULL** happens, or by specifying **COUNT[0]..COUNT[26]** with the Bits 0..26 of the time counter. Furthermore, the bits of the sweep counter can be monitored at the Sync outputs by specifying **SWEEP[0]..SWEEP[31]**. The time counter is incremented after 32 basic dwell times (16 for the P7886S) i.e. after about 1 nsec. If **Start event generation** is checked, a start event is inserted as a zero into the data stream and counted by the software.

The measurement can be stopped automatically after a specified number of sweeps by checking **Starts preset** or **Sweep preset**. In the former case the start events are used, in the latter case the hardware sweep counter. If **Single sweeps** is checked, after the specified number of sweeps the measurement is stopped, the FIFOs read out and then immediately the acquisition continues. The maximal possible event rate is lower in this mode, but it is made as sure as possible that during a sweep no data are lost by a full FIFO. If **DMA Mode** is checked, the data are acquired using DMA PCI bus master mode, otherwise by direct port control. The maximum possible data transfer rate is higher in DMA mode, but after a preset condition it takes some time to get out of the DMA read routine. Therefore for Single sweep mode it is preferable not to use DMA mode to reduce the dead time. A List file can be written by checking the corresponding checkbox **Write List file**. If **No Histogram** is checked, no histogramming is made. A series of measurements can be acquired into separate memory parts by checking **Sequential cycles** and specifying the number of cycles. Each single measurement should be terminated by any of the preset conditions, the complete run stops after performing the specified number of cycles.

If the checkbox **Eventpreset** is marked, the measurement will be stopped after acquiring more events than specified in the corresponding edit field. The events are counted only if they are within the **ROI** limits, i.e. \geq the lower limit and $<$ the upper limit. It is not necessary that this ROI is within the spectra range. Another possibility is to acquire data for a given time via the **Time preset**. In the edit field **Range** the length of the spectrum can be entered. A **Bin width** of 1 means the highest time resolution. The Binwidth can be chosen in powers of 2 up to 16384 times the elementary dwell time. If an **Acq. Delay** is specified, data are acquired in a sweep not before the specified time.

The **Inputs...** button opens the Input Thresholds dialog box. Here you can specify which one of the inputs you are using (NIM or +-2V) for the START and STOP input and the threshold level at the falling edge of the input signal. Check the corresponding checkbox of the used input. For the NIM inputs the combo box provides a choice between standard Fast NIM (-0.4 V) and customized, i.e. Voltage level set by hand between -0.8 .. -0.25 V (scroll bar or edit field). For the +-2V inputs there is a choice between Slow NIM (+1 V), ECL (-1.2 V), Fast NIM (-0.4 V) and customized (-1.5..+1.5V). In principle it is possible to gate a NIM input by the corresponding +-2V input, for this case the checkboxes of both inputs can be marked.

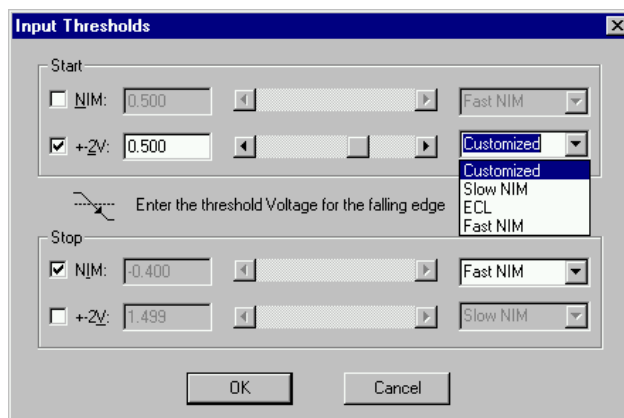

Figure 5.4: Input thresholds dialog

The „System...“ item in the settings menu opens the System Definition dialog box. If more than one P7886 modules are used, several cards can be combined to form one or up to 4 separate systems that can be started, stopped and erased by one command. In addition the use of the Digital Input / Output and the GO-Line can be defined: It can be used either to show the status of the MCA if the checkbox **Status Dig 0** (0..3 for more modules) is marked. At the respective pins +5 Volt are output if an acquisition is running and 0 V if not. The polarity can be inverted by checking **Invert**. Alternatively, it can be used for example with a sample changer by checking **Value inc. at Stop**. Here, the 8 bit value entered in the edit field (a number between 0 and 255) is output at the Dig I/O port. This value will always be incremented by 1 if the P7886 is stopped. The **Invert** checkbox allows to invert the logical level. See also the commands **pulse** and **waitpin** how to handshake a sample changer. The Radio buttons **Push-Pull** and **Open Drain** describe the output mode of the Dig I/O ports.

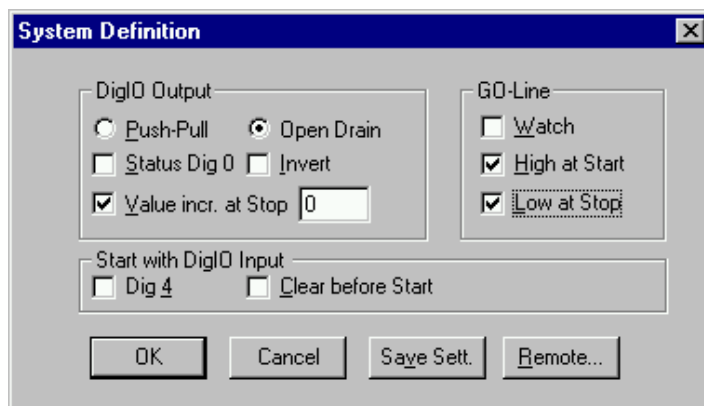

Figure 5.5: System Definition dialog box for a single P7886 card

It is also possible to use the digital input 4 as an external trigger for starting the system (more modules: Dig inputs 4..7 start systems 1..4) (**DESY control line**). If the corresponding checkbox is marked, a start command for the respective system will not immediately start the system. After the start command, the digital input will be permanently checked for its logical level. If the level changes from high to low, the data for the system is cleared and it will then be started. It will stop if the level returns to high (or vice versa if **Invert** is marked) and can again be restarted with the next level change. A stop command for the system will finish the digital input checking. By checking **Clear before Start** the spectra is cleared before the start. A stop command for the system will finish the digital input checking.

The Use of the GO-Line is controled via the 3 checkboxes **Watch**, **High at Start**, and **Low at Stop**. The GO line gates directly the hardware. "Low at Stop" means that the GO line is immediatly pulled down when a sweep preset is reached.

If more than one P7886 card is used, the system definition dialog box comes up as shown in Figure 5.6. Here the several units can be combined to form up to 4 separate systems that can be started, stopped and erased by one command.

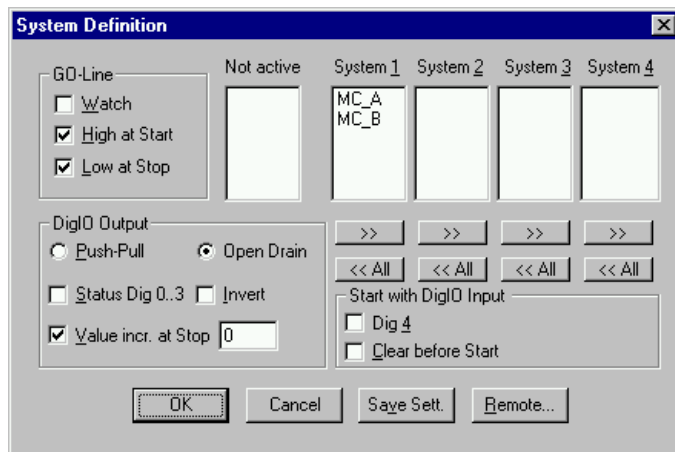

Figure 5.6: System Definition dialog box, two P7886 cards

In the shown setting a single system is formed. The two modules MC_A and MC_B are combined. System 1 can be started, stopped, erased, and continued with the respective commands in the Action 1 menu. It is also possible for example to form two independent systems 1 and 2: Click on the button labeled **<<All** below the list box „System1“ to remove all units from system 1. They are then shown in the „Not active“ list box. Then select unit A and click on the button labeled **>>** below the „System 1“ list box to include it into system 1 and perform the respective action for unit B and System 2.

OK accepts all settings and displays the value of P (the time counter preset value). **Cancel** rejects all changes. Pressing **„Save Settings“** stores all settings in the file **P7886A.INF** using the control language (see the following section)

This file is loaded at program start automatically and the parameters set. Together with each data file a header file with extension .886 is saved. This header also contains all settings and in addition some information like the date and time of the measurement and comments entered in the MCDWIN program.

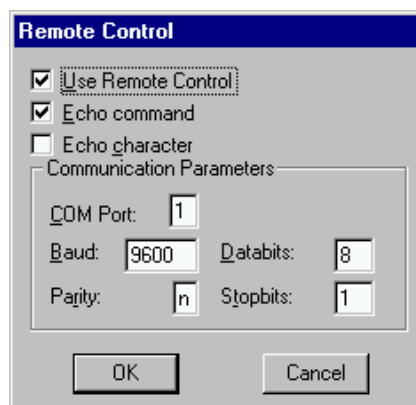

Figure 5.7: Remote control dialog

The **Remote...** button opens the Remote control dialog box. Here all settings can be made for the control of the P7886 server program via a serial port. If the Checkbox **Use Remote Control** is marked and the COMCTL.DLL is available (i.e. you have the **optional MCDLAN software**), the specified COM port will be used for accepting commands (see Control language). If **Echo command** is marked, the input line will be echoed after the newline character was sent. **Echo character**, on the other hand, immediately echoes each character.

5.1. Control Language

A sequence of commands that is stored in a file with extension .CTL can be executed by the P7886 server program with the „**Load**“ command. A lot of these commands are used in the configuration file P7886A.INF, also the header files with extension .886 contain such commands to set the parameters. Each command starts at the beginning of a new line with a typical keyword. Any further characters in a line may contain a value or a comment. Following methods are available to execute commands:

- Load the command file using the Load command in the file menu.
- Enable remote mode in the server and send commands via the serial connection. The COMCTL.DLL is necessary which is part of the optional available MCDLAN software.
- Open a DDE connection and send the commands via DDE as described in section 5.2. The application name for opening the DDE connection with the standard P7886 server program P7886.EXE is P7886, the topic is 7886-. Implemented are the DDE Execute to perform any command, and the DDE Request with items RANGE and DATA.
- Send the commands over a TCP/IP net using a remote shell and the optional available MCDLAN software. It is necessary to have a TCP/IP Winsock installed like the Trumpet winsockets and that the remote shell daemon program MCWNET is running. See the readme file on the installation disk.
- Send the commands via the DLL interface from LabVIEW, a Visual Basic program or any other application (software including the complete source code of the DLL and examples optional available).
- From your own Windows application, register a Windows message and then send the command as can be seen in the DLL source code.

The file P7886A.INF contains a complete list of commands for setting parameters. An example is:

```
digio=0 ; Use of digital I/O and GO-Line (hex):  
; bit 0: status dig 0..3  
; bit 1: Output digval and increment digval after stop  
; bit 2: Invert polarity  
; bit 3: Push-Pull output  
; bit 4..7: Input pins 4..7 Trigger System 1..4  
; bit 8: GOWATCH  
; bit 9: GO High at Start  
; bit 10: GO Low at Stop  
; bit 11: Clear before external triggered start  
digval=0 ; 8 bit digital I/O value for sample changer  
range=4096 ; sets histogram length  
fstchan=0 ; sets time offset = number of first channel / 32 (16 for P7886S)
```

sweepmode=3a0 ; (hex) sweepmode & 0xF: 0 = normal, 4=sequential
 ; bit 4: Softw. Start
 ; bit 5: DMA mode
 ; bit 6: Wrap around
 ; bit 7: Start event generation
 ; bit 8: DAC0 ON
 ; bit 9: DAC1 ON
 ; bit 10: DAC2 ON
 ; bit 11: DAC3 ON
swpreset=1 ; Sweep-Preset value
prena=0 ; Presets enabled (hex)
 ; bit 0: real time preset enabled
 ; bit 1: single sweeps enabled
 ; bit 2: sweep preset enabled
 ; bit 3: ROI preset enabled
 ; bit 4: Starts preset enabled
syncout=0 ; sync out (hex): bit 0..5 NIM sync out, bit 6..12 TTL sync out
 ; 0=OFF, 1=FIRST, 2=LAST, 3=FIFO1_FULL, 4=FIFO2_FULL,
 ; 5=COUNT[0],...,31=COUNT[26], 32..63=SWEEP[0]..SWEEP[31]
ssweeps=1 ; number of single sweeps for single sweeps mode
cycles=1 ; for sequential mode
dacnim=4cc04cc ; (hex) LOWORD: DAC0 value (NIM STOP)
 ; HIWORD: DAC1 value (NIM START)
dacomp=d550d55 ; (hex) LOWORD: DAC2 value (+-2V STOP),
 ; HIWORD: DAC3 value (+-2V START)
bitshift=0 ; Bin width (0: 1, 1:2, 2:4, 3:8,...)
rtpreset=50 ; Time preset (seconds)
evpreset=10000000 ; ROI preset
autoinc=0 ; Enable Auto increment of filename
datname=data\spec2.asc ; Filename
savedata=0 ; bit 0: 1 if auto save after stop
 ; bit 1: write list file
 ; bit 2: list file only, no histogram
fmt=dat ; Format (ASCII: asc, Binary: dat)
smoothpts=5 ; Number of points to average for a smooth operation
roimin=0 ; ROI lower limit (inclusive)
roimax=512 ; ROI upper limit (exclusive)
caluse=0 ; bit 0=1: Use calibration, higher bits: formula

calch0=0.00 ; First calibration point channel
calvl0=0.000000 ; First calibration point value
calch1=100.00 ; Second calibration point channel
calvl1=50.000000 ; Second calibration point value
caloff=0.000000 ; Calibration parameter: Offset
calfact=0.500000 ; Calibration parameter: Factor
calunit=nsec ; Calibration unit

The following commands perform actions and therefore usually are not included in the P7886.INF file:

fpll=2e9 ; Set PLL frequency (Hz) (P7886 S: around 1e9)
fpll+/-0.005e9 ; Change PLL frequency (Hz)
start ; Clears the data and starts a new acquisition. Further
; execution of the .CTL file is suspended until measurements
; stops due to a preset.
start2 ; Clears and starts system 2. Further execution suspended (see start).
start3 ; Clears and starts system 3. Further execution suspended (see start).
start4 ; Clears and starts system 4. Further execution suspended (see start).
halt ; Stops an acquisition if one is running.
halt2 ; Stops acquisition of system 2 if running.
halt3 ; Stops acquisition of system 3 if running.
halt4 ; Stops acquisition of system 4 if running.
cont ; Continues an acquisition. If a Realtime preset is already
; reached, the time preset is prolonged by the value which
; was valid when the start command was executed. Further
; execution of the .CTL file is suspended (see start).
cont2 ; Continues acquisition of system 2 (see cont).
cont3 ; Continues acquisition of system 3 (see cont).
cont4 ; Continues acquisition of system 4 (see cont).
savecnf ; Writes the settings into W7886.INF
MC_A ; Sets actual multichannel analyzer to MC_A for the rest of
; the controlfile.
MC_B ... MC_D ; Sets actual multichannel analyzer to MC_B ... MC_D for the
; rest of the controlfile.
savedat ; Saves data.
load ; Loads data; the filename must be specified before with a
; command datname=...
add ; Adds data; the filename must be specified before with a
; command datname=...
sub ; Subtracts data from actual multichannel analyzer; the filename
; must be specified before with a command datname=...
smooth ; Smoothes the data in actual multichannel analyzer

eras ; Clears the histogram

eras2 ; Clears the data of system 2.

eras3 ; Clears the data of system 3.

eras4 ; Clears the data of system 4.

sweep ; Starts a sweep by software

exit ; Exits the P7886 (and MCDWIN) programs

alert Message ; Displays a Messagebox containing Message and an OK
; button that must be pressed before execution can continue

waitinfo 5000 Message; Displays a Messagebox containing Message, an OK
; and an END button. After the specified time (5000 msec)
; the Messagebox vanishes and execution continues. OK
; continues immediately, END escapes execution.

beep * ; Makes a beep. The character '*' may be replaced with
; '?', '!' or left empty. The corresponding sound is defined in the
; WIN.INI file in the [sounds] section.

delay 4000 ; Waits specified time (4000 msec = 4 sec).

run controlfile ; Runs a sequence of commands stored in controlfile. This
; command cannot be nested, i.e. from the controlfile called a
; second run command cannot be executed.

onstart command ; The command is executed always after a start action when the
; acquisition is already running. The command can be any valid
; command, also 'run controlfile' is possible.

onstart off ; Switches off the 'onstart' feature. Also a manual Stop command
; switches it off.

onstop command ; The command is executed always after a stop caused by a
; preset reached. This can be used to program measure
; cycles. For example the command 'onstop start' makes a
; loop of this kind.

onstop off ; Switches off the 'onstop' feature. Also a manual Stop command
; switches it off.

lastrun=5 ; Defines the file count for the last run in a measure cycle. After a
; file with this count or greater was saved with autoinc on, instead
; of the 'onstop command' the 'onlast command' is executed.

numruns=5 ; Defines the file count for the last run in a measure cycle. The
; last count is the present one plus the numruns number. After a
; file with this count was saved with autoinc on, instead of the
; 'onstop command' the 'onlast command' is executed.

onlast command ; The command is executed after a stop caused by a preset
; reached or trigger instead of the 'onstop command', when the
; last file count is reached with autoinc on. This can be used to
; finish programmed measure cycles.

onlast off ; Switches off the 'onlast' feature. Also a manual Stop command
; switches it off.

pulse 100 ; Output a TTL pulse of 100 msec duration at dig 3 (pin 11)

waitpin 4000 ; Waits 4000 ms for going the level at dig 7 (pin 13) going low.
; After a timeout a Message box warns and waits for pressing OK.
; Can be used for connecting a sample changer.

exec program ; Executes a Windows program or .PIF file. Example:
; exec notepad test.ctf opens the notepad editor and loads
; test.ctf.

fitrois ; Makes a single peak Gaussian fit for all ROIs in the active
; Display of MCDWIN and dumps the result into a logfile. This is
; performed by the MCDWIN program and therefore can be
; made only if this application is running.

fitrois MC_A ; Similar to the fitroi command, but using the argument allows to
; specify which spectrum should be evaluated independently of
; which child window is activated in MCDWIN

autocal ; Makes a single peak Gaussian fit for all ROIs in the active
; Display of MCDWIN for which a peak value was entered in the
; MCDWIN Region Edit dialog and uses the results for a
; calibration. This is performed by the MCDWIN program and
; therefore can be made only if this application is running.

autocal MC_A ; Similar to the autocal command, but using the argument allows
; to specify which spectrum should be evaluated independently of
; which child window is activated in MCDWIN

The following commands make sense only when using the serial line, TCP/IP or DLL control:

MC_A? ; Sends the status of MC_A via the serial port and make MC_A
; actual.

MC_B? ; Sends the status of MC_B via the serial port and make MC_B
; actual.

MC_C? ; Sends the status of MC_C via the serial port and make MC_C
; actual.

MC_D? ; Sends the status of MC_D via the serial port and make MC_D
; actual.

? ; Send the status of the actual multi channel analyzer

sendfile *filename* ; Sends the ASCII file named *filename* over the serial line.

The execution of a control file can be ended from the Server or MCDWIN with the Halt button.

5.2. Controlling the P7886 Windows Server via DDE

The P7886 program can be a server for DDE (Dynamic Data Exchange). Many Windows software packages can use the DDE standard protocols to communicate with other Windows programs, for example GRAMS, FAMOS or LabVIEW. In the following the DDE capabilities of the P7886 program are described together with a demo VI („Virtual Instrument“) for LabVIEW. It is not recommended to use the DDE protocol for LabVIEW, as also a DLL interface is available that is much faster. The following should be seen as a general description of the DDE conversation capabilities of the P7886 program.

5.2.1. Open Conversation

application: P7886

topic: 7886

Any application that wants to be a client of a DDE server, must open the conversation first by specifying an application and a topic name. The application name is P7886 and the topic is 7886.

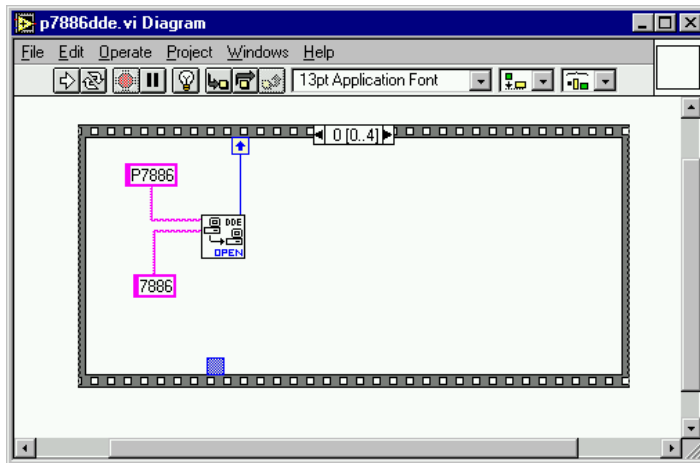

Figure 5.8: Opening the DDE conversation with the P7886 in LabVIEW

5.2.2. DDE Execute

The DDE Execute command can be used to perform any action of the P7886 program. Any of the Control command lines described in section 5.1 can be used. For example a sequence of control commands saved in a file TEST.CTL can be executed by specifying the command

```
RUN TEST.CTL
```

The P7886 program then executes the command and, after finishing, it sends an Acknowledge message to the DDE client. This can be used to synchronize the actions in both applications.

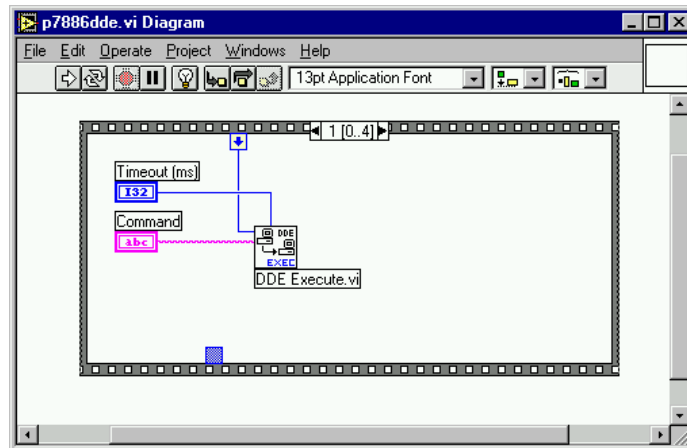

Figure 5.9: Executing a P7886 command from a LabVIEW application

5.2.3. DDE Request

The DDE Request is a message exchange to obtain the value of a specified item. Only two items are defined for DDE request up to now: RANGE and DATA. The value is obtained as an ASCII string, i.e. it must be converted by the client to get the numbers. All other parameters concerning the W7886 Setup can be obtained by the client application by reading and evaluating the configuration file.

RANGE

The RANGE item can be used to obtain the total number of data.

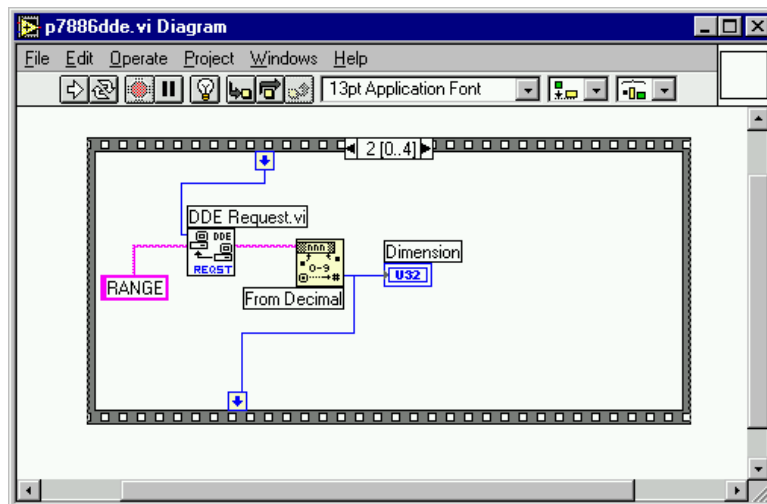

Figure 5.10: Getting the total number of data with LabVIEW

DATA

With the DATA item the data is obtained. The value of this item is a multiline string that contains in each line a decimal number as an ASCII string.

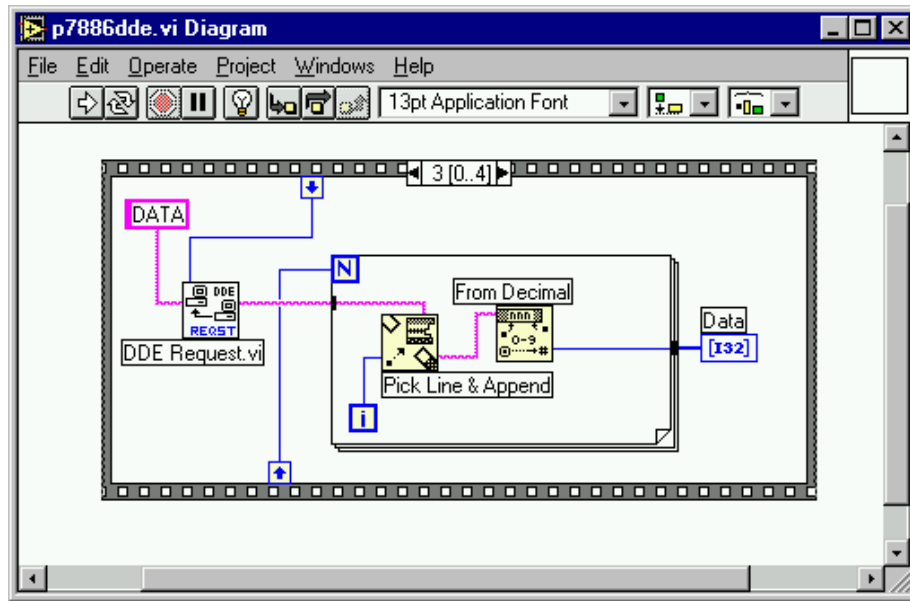

Figure 5.11: Getting the data with LabVIEW

5.2.4. Close Conversation

After finishing the DDE communication with the p7886 program, it must be closed.

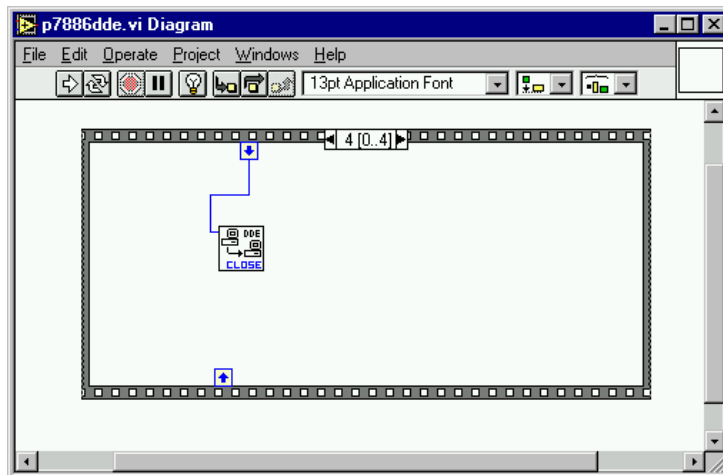

Figure 5.12: Closing the DDE communication in LabVIEW

The following figure shows the „Panel“ of the described VI for LabVIEW.

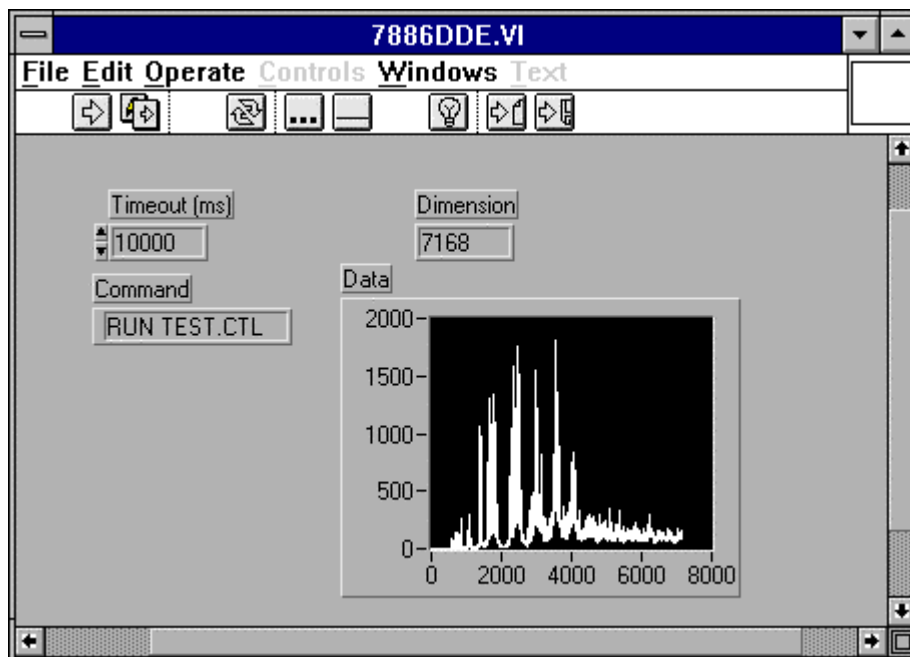

Figure 5.13: Control Panel of the demo VI for LabVIEW

5.2.5. DDE Conversation with GRAMS/386

The following file GRAMS886.CIF can be used to get the P7886 data into GRAMS/386 via DDE using the „Collect“ menu:

```
P7886 DDE Test
Query
P7886
7886
DATA

save

end
spc
1 second
```

5.3. Controlling the P7886 Windows Server via DLL

The P7886 server program provides access to all functions, parameters and data via a DLL („dynamic link library“). So the server can be completely controlled by the MCDWIN software that provides all necessary graphic displays.

In the following some parts of the header and definition files of the DP7886.DLL are listed, that may help an experienced programmer to use the DLL for own applications. The arguments „item, nDevice, nDisplay, nSystem“ are only for compatibility with other devices controlled by the MCDWIN software and must be zero.

NOTE:

The complete documented **sourcecode of the DLL** including fundamental VI's and an example VI for **LabVIEW** and an example **Visual Basic** program is available as an **option**.

```

typedef struct{
    int started;           // aquisition status: 1 if running, 0 else
    double runtime;       // running time in seconds
    double totalsum;      // total events
    double roisum;        // events within ROI
    double roirate;       // acquired ROI-events per second
    double nettosum;      // ROI sum with background subtracted
    double sweeps;        // Number of sweeps
    double stevents;      // Start Events
    unsigned long maxval; // Maximum value in spectrum
} ACQSTATUS;

typedef struct{
    unsigned long range; // spectrum length
    long prena;          // bit 0: realtime preset enabled
                        // bit 1: single sweeps enabled
                        // bit 2: sweep preset enabled
                        // bit 3: ROI preset enabled
                        // bit 4: Starts preset enabled
    long ssweeps;        // number of single sweeps for
                        // single sweeps mode
    unsigned long roimin; // lower ROI limit
    unsigned long roimax; // upper limit: roimin <= channel < roimax
    double eventpreset;   // ROI preset value
    double timepreset;    // time preset value
    long savedata;        // bit 0: 1 if auto save after stop
                        // bit 1: write listfile
                        // bit 2: listfile only, no histogram
    long fmt;             // format type: 0 == ASCII, 1 == binary
    long autoinc;         // 1 if auto increment filename
    long cycles;          // for sequential mode
    long sweepmode;       // sweepmode & 0xF:
                        // 0 = normal, 4=sequential
                        // bit 4: Softw. Start
                        // bit 5: DMA mode
                        // bit 6: Wrap around
                        // bit 7: Start event generation
                        // bit 8: DAC0 ON
                        // bit 9: DAC1 ON
                        // bit 10: DAC2 ON
                        // bit 11: DAC3 ON
    long syncout;         // sync out; bit 0..5 NIM syncout,
                        // bit 6..12 TTL syncout
                        // 0=OFF, 1=FIRST, 2=LAST, 3=FIFO1_FULLL, 4=FIFO2_FULLL,
                        // 5=COUNT[0],...,31=COUNT[26],
                        // 32...63=SWEEP[0]..SWEEP[31]
    long bitshift;        // Binwidth = 2 ^ (bitshift)
    long digval;          // digval=0..255 value for samplechanger
    long digio;           // Use of Dig I/O, GO Line:
                        // bit 0: status dig 0..3
                        // bit 1: Output digval and
                        // increment digval after stop
                        // bit 2: Invert polarity
                        // bit 3: Push-Pull output
                        // bit 4..7: Input pins 4..7
                        // Trigger System 1..4
                        // bit 8: GOWATCH
                        // bit 9: GO High at Start
                        // bit 10: GO Low at Stop
                        // bit 11: Clear before
                        // ext. triggered Start

```

```

long dacnim;           // LOWORD: DAC0 value (NIM STOP)
                      // HIWORD: DAC1 value (NIM START)
long daccomp;         // LOWORD: DAC2 value (+-2V STOP),
                      // HIWORD: DAC3 value (+-2V START)
double swpreset;      // sweep preset value
long nregions;        // number of regions
long caluse;          // bit 0 == 1 if calibration used,
                      // higher bits: formula
double fstchan;       // first time channel * 32
long active;          // 1 for module enabled in system 1
long calpoints;       // number of calibration points
} ACQSETTING;

typedef struct{
    unsigned long HUGE *s0;           // pointer to spectrum
    unsigned long far *region;        // pointer to regions
    unsigned char far *comment0;      // pointer to strings
    double far *cnt;                  // pointer to counters
    HANDLE hs0;
    HANDLE hrg;
    HANDLE hcm;
    HANDLE hct;
} ACQDATA;

typedef struct {
    int nDevices;           // Number of spectra = number of modules
    int nDisplays;         // Number of active displays 0...nDevices
    int nSystems;          // Number of systems 0...4
    int bRemote;           // 1 if server controlled by MCDWIN
    unsigned int sys;      // System definition word:
                          // bit0=0, bit1=0: MCD#0 in system 1
                          // bit0=1, bit1=0: MCD#0 in system 2
                          // bit0=0, bit1=1: MCD#0 in system 3
                          // bit0=1, bit1=1: MCD#0 in system 4
                          // bit2=0, bit3=0: MCD#1 in system 1 ...
                          // bit6=1, bit7=1: MCD#3 in system 4
} ACQDEF;

/**/ FUNCTION PROTOTYPES (do not change) /**/
BOOL APIENTRY DllMain(HANDLE hInst, DWORD ul_reason_being_called, LPVOID
lpReserved);
VOID APIENTRY StoreSettingData(ACQSETTING FAR *Setting, int nDisplay);
// Stores Settings into the DLL
int APIENTRY GetSettingData(ACQSETTING FAR *Setting, int nDisplay);
// Get Settings stored in the DLL
// Store System Definition into DLL
VOID APIENTRY StoreStatusData(ACQSTATUS FAR *Status, int nDisplay);
// Store the Status into the DLL
int APIENTRY GetStatusData(ACQSTATUS FAR *Status, int nDisplay);
// Get the Status
VOID APIENTRY Start(int nSystem); // Start
VOID APIENTRY Halt(int nSystem); // Halt
VOID APIENTRY Continue(int nSystem); // Continue
VOID APIENTRY NewSetting(int nDevice);
// Indicate new Settings to Server
UINT APIENTRY ServExec(HWND ClientWnd);
// Execute the Server P7886.EXE
VOID APIENTRY StoreData(ACQDATA FAR *Data, int nDisplay);
// Stores Data pointers into the DLL
int APIENTRY GetData(ACQDATA FAR *Data, int nDisplay);
// Get Data pointers
long APIENTRY GetSpec(long i, int nDisplay);
// Get a spectrum value
VOID APIENTRY SaveSetting(void); // Save Settings

```

```

int APIENTRY GetStatus(int nDevice);
// Request actual Status from Server
VOID APIENTRY Erase(int nSystem); // Erase spectra
VOID APIENTRY SaveData(int nDevice); // Saves data
VOID APIENTRY GetBlock(long FAR *hist, int start, int end, int step,
int nDisplay); // Get a block of spectrum data
VOID APIENTRY StoreDefData(ACQDEF FAR *Def);
int APIENTRY GetDefData(ACQDEF FAR *Def);
// Get System Definition
VOID APIENTRY LoadData(int nDisplay); // Loads data
VOID APIENTRY AddData(int nDisplay); // Adds data
VOID APIENTRY SubData(int nDisplay); // Subtracts data
VOID APIENTRY Smooth(int nDisplay); // Smooth data
VOID APIENTRY NewData(void); // Indicate new ROI or string Data
VOID APIENTRY HardwareDlg(int item);
// Calls the Settings dialog box
VOID APIENTRY UnregisterClient(void);
// Clears remote mode from MCDWIN
VOID APIENTRY DestroyClient(void); // Close MCDWIN
UINT APIENTRY ClientExec(HWND ServerWnd);
// Execute the Client MCDWIN.EXE
int APIENTRY LVGetDat(unsigned long HUGE *datp, int nDisplay);
// Copies the spectrum to an array
VOID APIENTRY RunCmd(int nDisplay, LPSTR Cmd);
// Executes command
int APIENTRY LVGetRoi(unsigned long FAR *roip, int nDisplay);
// Copies the ROI boundaries to an array
int APIENTRY LVGetCnt(double far *cntp, int nDisplay);
// Copies Cnt numbers to an array
int APIENTRY LVGetStr(char far *strp, int nDisplay);
// Copies strings to an array

EXPORTS
; Functions in dp7886.c
StoreSettingData @2
GetSettingData @3
StoreStatusData @4
GetStatusData @5
Start @6
Halt @7
Continue @8
NewSetting @9
ServExec @10
StoreData @11
GetData @12
GetSpec @13
SaveSetting @14
GetStatus @15
Erase @16
SaveData @17
GetBlock @18
StoreDefData @19
GetDefData @20
LoadData @21
NewData @22
HardwareDlg @23
UnregisterClient @24
DestroyClient @25
ClientExec @26
LVGetDat @27
RunCmd @28
AddData @29
LVGetRoi @30
LVGetCnt @31
LVGetStr @32
SubData @33
Smooth @34

```

StoreExtSettingData	@35
GetExtSettingData	@36

6. MCDWIN Software

The window of the MCDWIN program is shown here. It enables the full control of the P7886 card via the server program to perform measurements, save data and to show the data online in several windows.

The server program P7886.EXE automatically starts MCDWIN. If you try to start MCDWIN in advance to the server, a message box warns that you should start the server first.

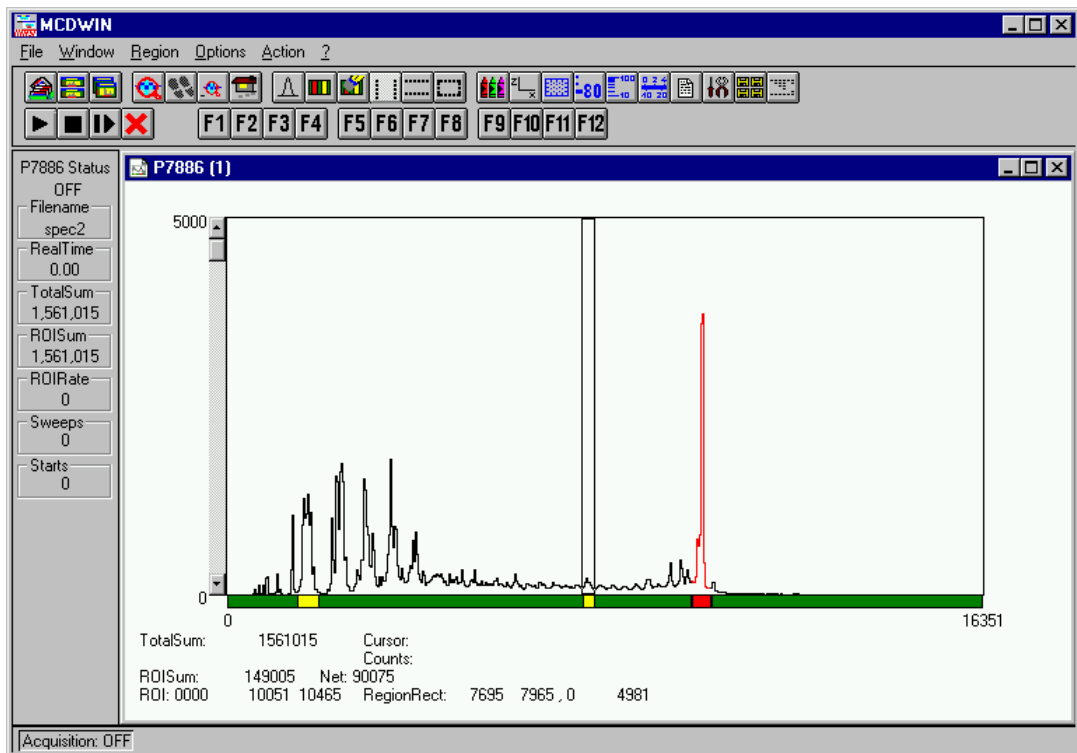

Figure 6.1: MCDWIN main window

A status window at the left side gives all information about the status of the P7886. A toolbar provides fast access to many used functions in the menu. A status bar at the bottom gives help about the meaning of the toolbar icons. A cursor appears when clicking the left mouse button inside the graphics area. To get rid of the cursor, make a double click with the right mouse button outside the graphics area. To define a region, press the right mouse button, and while keeping the button pressed, drag a rectangle. In zoomed state a scrollbar appears that allows to scroll through the spectrum.

MCDWIN has now (v 2.5) also viewing capabilities for two dimensional spectra. A single spectrum can be converted into a two dimensional one by specifying the x dimension in the display option dialog. It is possible to drag a rectangle and zoom into this rectangle. Rectangular ROIs can be set and the ROISum and Net ROISum is displayed. The Net Sum is calculated the same way like in the single view, by subtracting a linear interpolated background from the both outmost channels in x-direction. This Net sums are then summed up in y-direction. The ROI editing dialog is changed into a Rectangular Editing dialog for MAP and ISO displays. The Cursor can be moved in x and y direction using the mouse and the arrow keys, in ISO display only using the arrow keys.

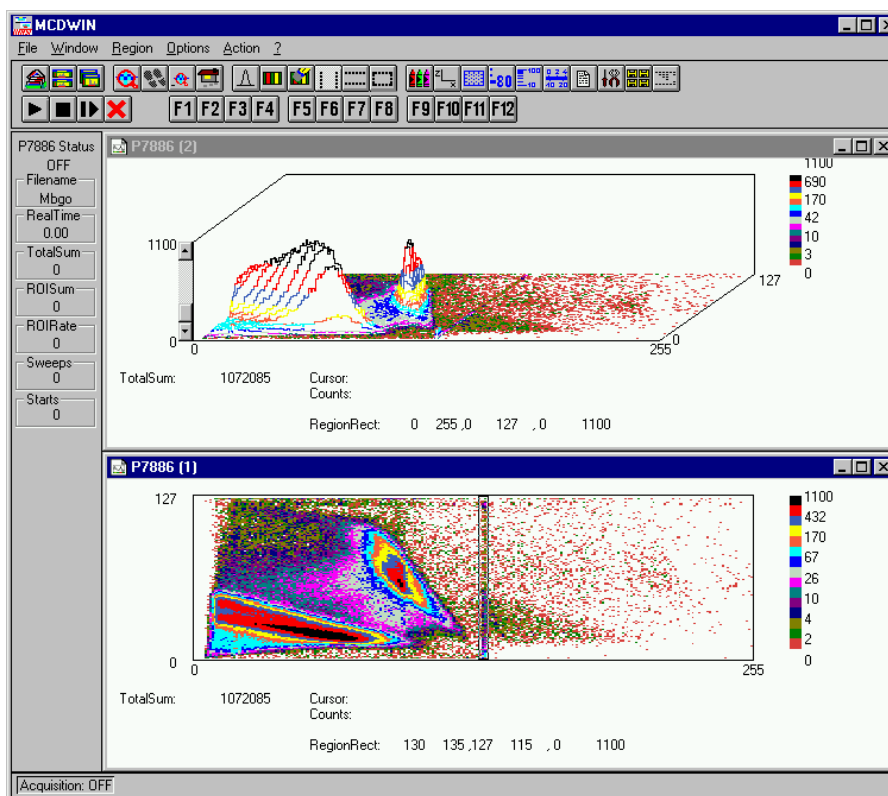

Figure 6.2: MCDWIN Map and Isometric display

A status window at the left side gives all information about the status of the P7886. A toolbar provides fast access to many used functions in the menu. A status bar at the bottom gives help about the meaning of the toolbar icons. A cursor appears when clicking the left mouse button inside the graphics area. The cursor can be moved using the arrow keys. To get rid of the cursor, make a double click with the right mouse button outside the graphics area. To define a region, press the right mouse button, and while keeping the button pressed, drag a rectangle. In zoomed state a scrollbar appears that allows to scroll through the spectrum.

In the following the several menu functions are described together with the corresponding toolbar icons.

6.1. File Menu

Load..., Add..., Save, Save As...

These menu items provide the usual functions for loading and saving data common to most Windows programs. When saving data, you have the choice between binary (.DAT) and ASCII (.ASC) format. When you load data, select a header file (extension .886). This file contains the information about the length and format of the data file, which is then automatically read.

It is also possible to load a file with extension .CTL containing commands which are then executed. With „Add“ the data is added to the present data. The data loaded from a file is corrected according to the calibration, if available.

Open New...



With the Open New menu item or the corresponding icon a new Display window will be created and shown as the active window.

Open All

By selecting the Open All menu item, all available Displays are shown. The window of the last opened Display becomes active.

Print...

The Print menu item prints a Display to the printer. Only the visible part of the spectra will be printed. The size and position of the graphic on paper can be adjusted (see Figure 6.4: Single Gaussian Peak Fit).

NOTE:

If printing takes a long time and disk activity is high, please note the following: The picture for the printing is first built in the memory, but it may need quite a lot of memory if the printer resolution is high and therefore Windows makes intense virtual memory swapping to disk if for example only 8 MB RAM are available. Therefore it is recommended: never use a 600 dpi printer driver for the printout of spectra. For example for an HP Laser 4, install the PCL driver and use 300 dpi. The PCL driver is also much more effective than a Postscript driver, printing is much faster. With 600 dpi, the maximum figure size is indeed limited to about 12 cm x 7 cm (Windows cannot handle on an easy way bitmaps larger than 16 MB).

Setup Printer...

The Setup Printer menu item allows to configure the printer.

Exit

The Exit menu item exits the MCDWIN.

6.2. Window Menu

The Window menu allows to arrange the Display windows.

Tile

With the Tile menu item or clicking the corresponding icon, all opened and displayed MCDWIN Display windows are arranged over the full MCDWIN client area trying to make the same size for all windows.

Cascade

The Cascade menu item or respective icon arranges all windows in a cascade.

Arrange Icons

By the Arrange Icons menu item, the minimized MCDWIN Display windows are arranged in a series at the bottom of the MCDWIN client area.

Close All

By selecting the Close All menu item, all Display windows are closed.

Window list

At the end of the Window menu, all created Display windows are listed with their names, the current active window is checked. By selecting any of the names, this window becomes the active and is displayed in front of all others.

6.3. Region Menu

The Region menu contains commands for Regions and ROIs (Regions of Interest). A Region can be marked in a display with the mouse using the right mouse button by dragging a rectangle over the area one is interested in. A ROI, i.e. an already defined region in a single spectra can be shown zoomed by double-clicking with the left mouse button on the corresponding colored area in the bar at the bottom of the spectra display. A single mouse click with the left button on the corresponding colored area makes this to the active ROI and lets the counts contained in this ROI be displayed in the information lines of the respective window.

Zoom



The Zoom item or respective icon enlarges a Region to the maximum Display Spectrum size.

Back



The Back menu item or clicking the corresponding icon restores the last zoom view. A successive Back command returns to the previous view.

Zoom Out



The Zoom Out menu item or clicking the corresponding icon reduces the actual zoom factor by 2, if applicable.

Home



Clicking the Home menu item or the corresponding icon restores a Display to the basic configuration.

Shape

Selecting the Shape menu item opens a submenu with the items Rectangle, X-Slice, Y-Slice, and Polygon to choose the ROI shape.

Rectangle



Sets the region shape to a rectangle with arbitrary dimensions. To enter the rectangular region, press the right mouse button, drag a rectangle, and release the button to define the region.

X-Slice



Sets the Region shape to the rectangle with maximum height.

Y-Slice

Sets the Region shape to the rectangle with maximum width.

Create

The Create menu item creates a new ROI from the current marked Region.

Delete

By selecting the Delete menu item or the respective icon, the current active ROI is deleted and the previously defined ROI is activated.

Edit...

With the Edit item, a dialog box is opened which allows to edit the ROI list, i.e. create a new one, delete, change and activate an existing ROI. Also the peak values (e.g. energy, mass etc.) for an automatic calibration can be entered here. A ROI can be edited and added to the list. It can also be made to the „Active ROI“, that is the special ROI that is used by the server program to calculate the events within this ROI and look for an event preset. The ROI list can be cleared and can be written to a file with extension .CTL, which can be directly loaded into the server to restore the ROI list.

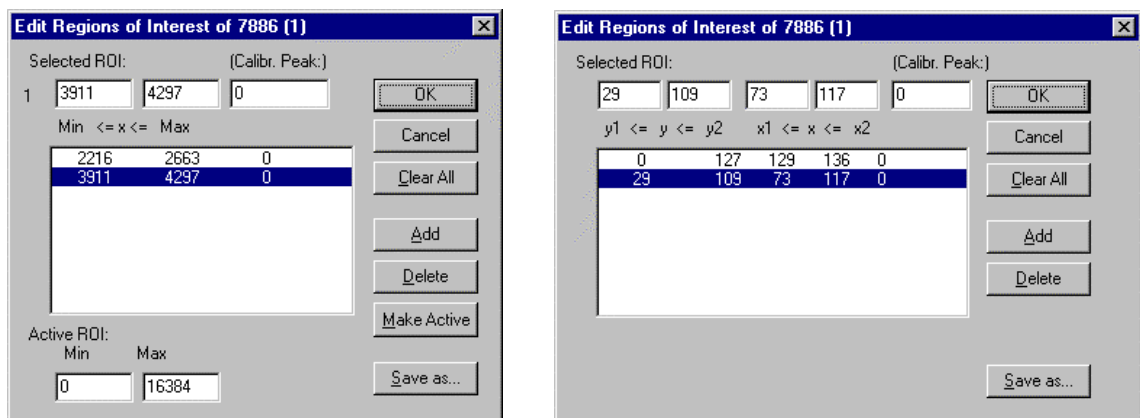

Figure 6.3: ROI Editing dialog box, left: Single spectra, right: 2D spectra

The selected ROI can be changed by clicking on it in the ROI list. In the MCDWIN spectrum display the total and net sum of the selected ROI is displayed.

Fit...

By selecting the Fit... menu item or the respective icon, A single Gaussian peak fit with linear background is performed for the currently marked region. The fitted curve is displayed and a dialog box shows the results:

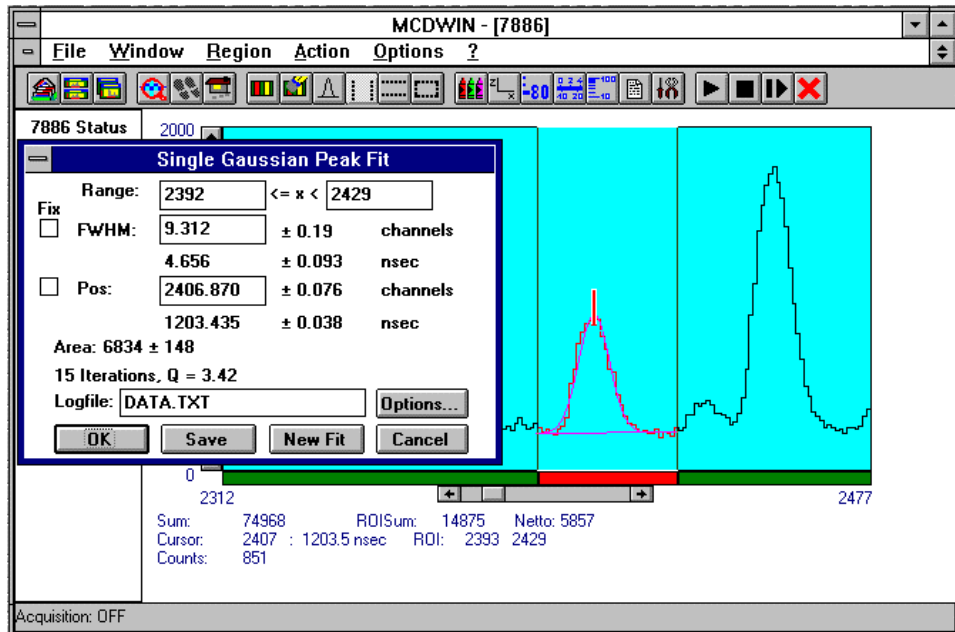

Figure 6.4: Single Gaussian Peak Fit

The full width at half maximum FWHM and Position of the Gaussian can be changed and a **New Fit** can be performed, they even can be fixed to the entered value by marking the respective checkbox. The Position and FWHM are displayed in channels and also in calibrated units, if a calibration is available. The area of the Gaussian is also shown. For all values also the standard deviations are given. The value of Q is the normalized χ^2 . To take into account the systematic error of the lineshape, you may multiply the errors with the squareroot of Q. Click on **Save** to append a line containing the results to a **Logfile** with the specified name. **OK** closes the dialog and the fitted function remains in the display - also if the display is refreshed -, whereas after **Cancel** the curve no longer will be shown in a refreshed display. **Options...** opens a new dialog box to define the information in the logfile:

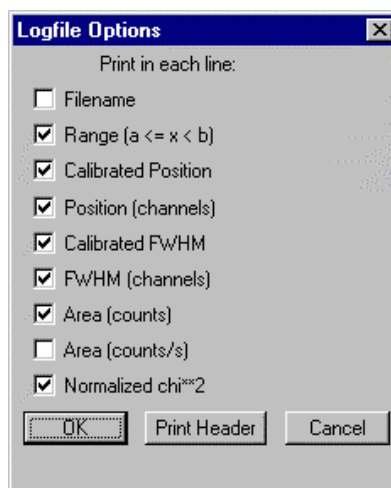

Figure 6.5: Log file Options for the Single Gaussian Peak Fit

The several quantities are written in standard text format with Tabs as separators and a Newline character at the end of each line, so the file can be read with standard calculation programs like EXCEL. Click on **Print Header** to write a header line.

Fit ROIs

With the Fit ROIs item, for all ROIs a Single Gaussian Peak Fit is performed and the results are dumped into the logfile.

Auto Calib

Makes a Gauss fit for all ROIs in the active Display for which a peak value was entered, and performs a calibration using the fit results.

6.4. Options Menu

The Options Menu contains commands for changing display properties like scale, colors etc., hardware settings, calibration and comments.

Colors...



The Colors menu item or respective icon opens the Colors dialog box.

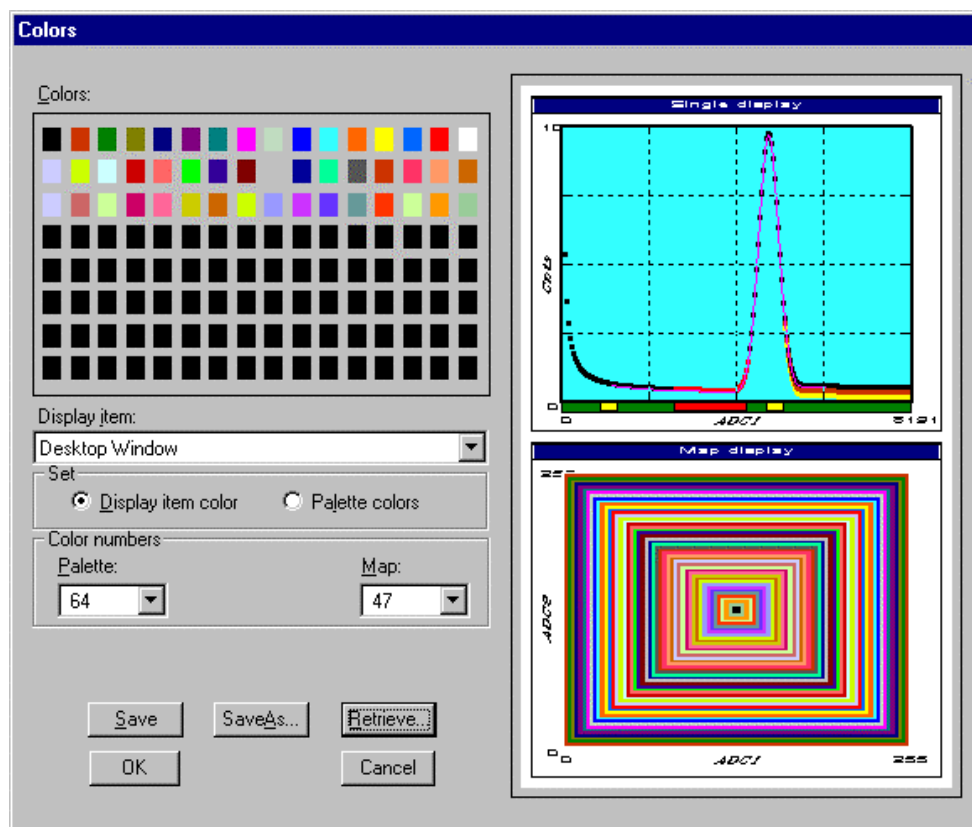

Figure 6.6: Colors dialog box

It changes the palette or Display element color depending on which mode is chosen. The current color and palette setup may be saved or a new one can be loaded.

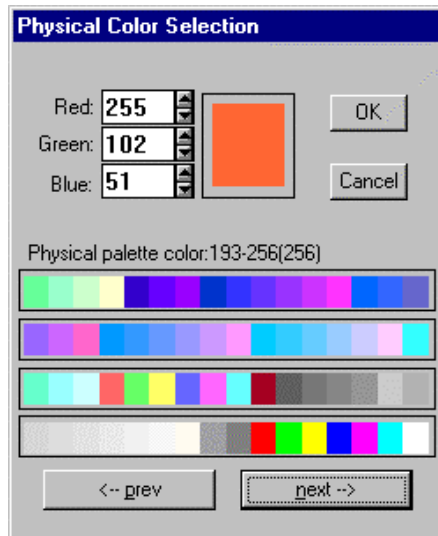

Figure 6.7: Color Palette dialog box

To change one of the colors, select "Palette colors" and click on one of the colors. In the Color Palette dialog box the RGB values can be edited or for a 256 color video driver one of the Physical palette colors can be chosen.

Display...



The Display menu item or the corresponding icon opens for single spectra the Single view dialog box.

Here the graphic display mode of single spectra can be chosen. The 'type' combo box gives a choice between **dot**, **histogram**, **spline I** and **line**.

'Dot' means that each spectra point is shown as a small rectangle, the size of this rectangle can be adjusted with the **size** combo box. 'Histogram' is the usual display with horizontal and vertical lines, 'spline I' means linear interpolation between the points, and 'line' means vertical lines from the ground to each spectra point.

If the displayed spectra range contains more channels as pixel columns are available in the video graphic display, usually only the maximum value of the channels falling into that pixel columns is displayed. But it can also explicitly specified by marking the checkboxes „**Max Pixel**“, „**Mean Pixel**“ or „**Min Pixel**“ which value will be displayed. It is also possible to display all three possible values in different colors that can be chosen in the colors dialog. For the „Mean Pixel“ a Threshold value can be entered; channel contents below this value then aren't taken into account for the mean value calculation.

It is possible to change to a two dimensional view of the spectrum by specifying the x Dimension and clicking the button ">> MAP".

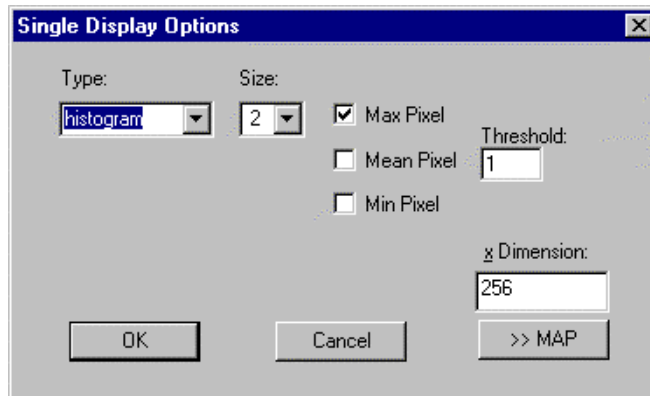

Figure 6.8: Single View dialog box

For MAP displays the Display Options dialog is changed and allows a choice between four Graphic types: **bitmap dot**, **vector dot**, **bitmap contour** and **vector contour**. Bitmap Dot is recommended as a standard, because it makes a good and fast display. Vector Contour paints colored contour lines. To calculate the lines takes a lot of time and causes the mouse pointer changing to an hourglass. But it gives very impressive colored pictures suited especially for presentation and when looking carefully at spectra details.

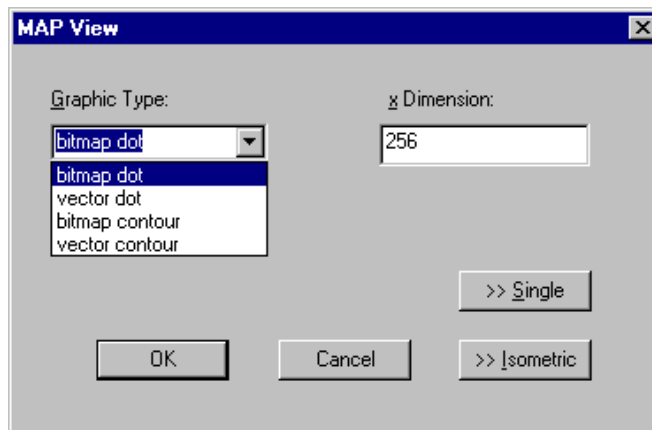

Figure 6.9: MAP View dialog box

From the MAP View dialog it is possible to change to Single view by clicking ">> Single" or change to Isometric View by clicking ">> Isometric".

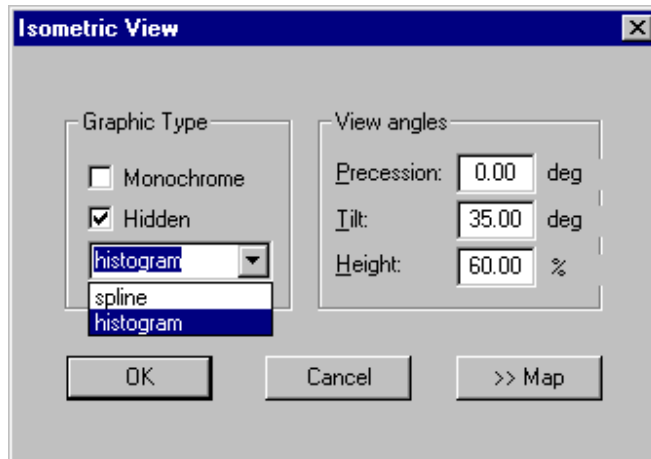

Figure 6.10: Isometric View dialog box

In isometric mode several single spectra are drawn behind each other. The **Precession** angle around the vertical axis can be chosen in multiples of 90 degrees. The **Tilt** angle is between the x and y axis and can be chosen between 15 and 89 degrees. The **Height** specifies the percentage of the z-axis length respective to the whole drawing, it can be entered between 0 and 99. With **hidden** it can be specified whether the hidden parts are not drawn. If "Monochrome" is checked, the spectra are painted monochrome, otherwise in color.

Axis...



By the Axis... menu item or the respective icon, the Axis Parameters dialog box is opened.

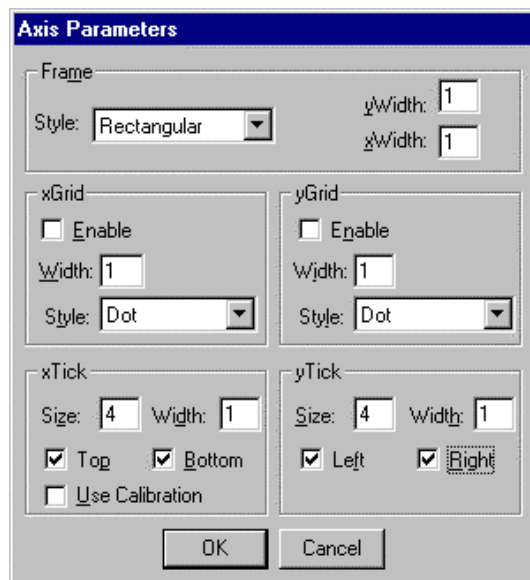

Figure 6.11: Axis Parameter dialog box

It provides many choices for the axis of a display. The frame can be rectangular or L-shape, the frame thickness can be adjusted (xWidth, yWidth). A grid for x and y can be enabled, the style can be chosen between Solid, Dash, DashDot and DashDotDot. Ticks on each of the four frame borders can be enabled, the tick length and thickness can be chosen. The style of the axis

labeling depends on enabled ticks at the bottom respective left side: If no ticks are enabled there, only the lowest and highest values are displayed at the axis, otherwise the ticks are labeled.

Scaling...



The Scaling menu item or the corresponding icon opens the Scale Parameters dialog box.

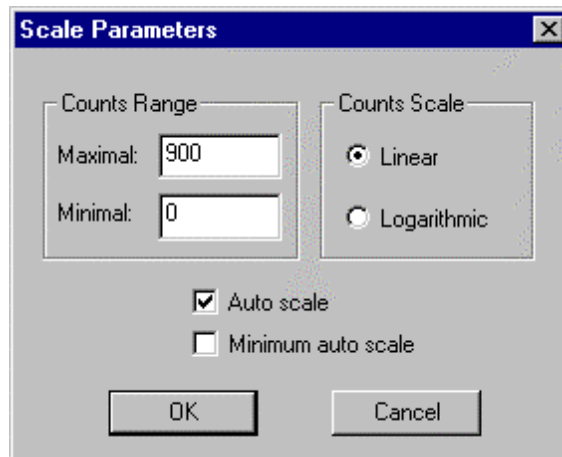

Figure 6.12: Scale Parameters dialog box

It allows to change the ranges and attributes of a Spectrum axis. By setting the Auto scaling mode, the MCDWIN will automatically recalculate the y-axe's maximum value for the visible Spectrum region only. To keep the same height of the visible region for a longer time, deselect the Auto scaling mode. Then with the scroll bar thumb one can quickly change the visible region scale, otherwise the scale will be changed automatically. The Minimum auto scale mode helps to display weak structures on a large background.

Lin / Log scale



Chose between Linear or Logarithmic scaling. All options have effect only on the active Display.

Calibration...



Using the Calibration menu item or the corresponding icon opens the Calibration dialog box.

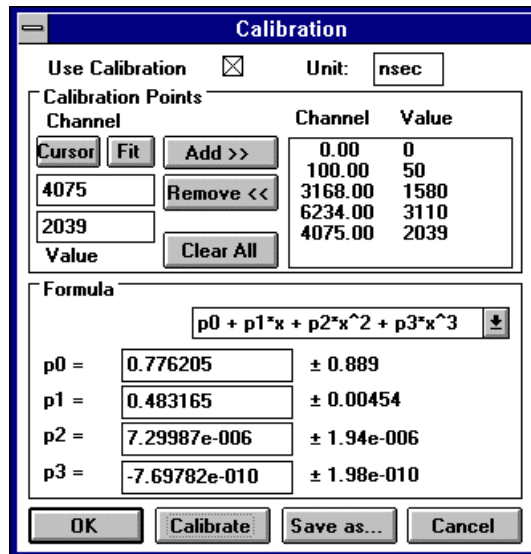

Figure 6.13: Calibration dialog box

Make a choice of several calibration formulas. Enter some cursor positions and the corresponding values (e.g. energy, mass etc.), click on Add and then on Calibrate. The obtained coefficients can be inspected together with the statistical error, or they can be changed and entered by hand. If 'use calibration' is enabled, the calibrated values are displayed together with the channel position of the cursor.

Comments...



Up to 13 comment lines with each 60 characters can be entered using the Comments dialog box. The content of these lines is saved in the data header file. The first line automatically contains the time and date when a measurement was started. The titles of each line can be changed by editing the file COMMENT.TXT.

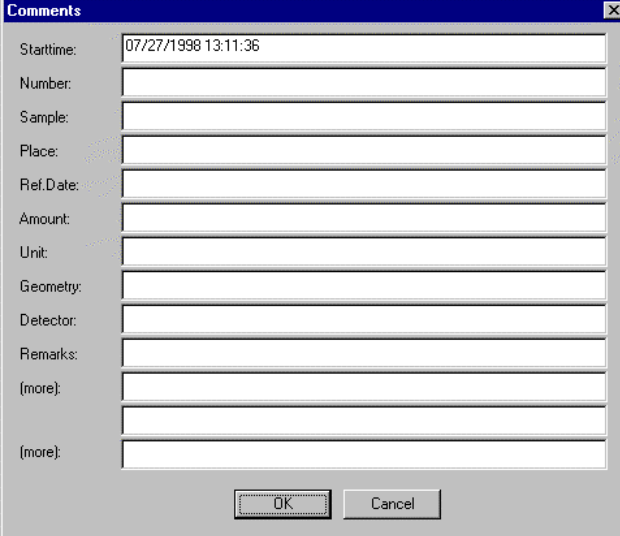

The 'Comments' dialog box is a standard Windows-style window with a title bar containing the text 'Comments' and a close button. The main area contains several text input fields, each with a label to its left: 'Starttime:' (containing '07/27/1998 13:11:36'), 'Number:', 'Sample:', 'Place:', 'Ref.Date:', 'Amount:', 'Unit:', 'Geometry:', 'Detector:', 'Remarks:', '(more):', and another '(more):'. At the bottom of the dialog are two buttons: 'OK' and 'Cancel'.

Figure 6.14: Comments dialog box

Range, Preset...



This dialog box allows to make all P7886 settings (ref. the Server description).

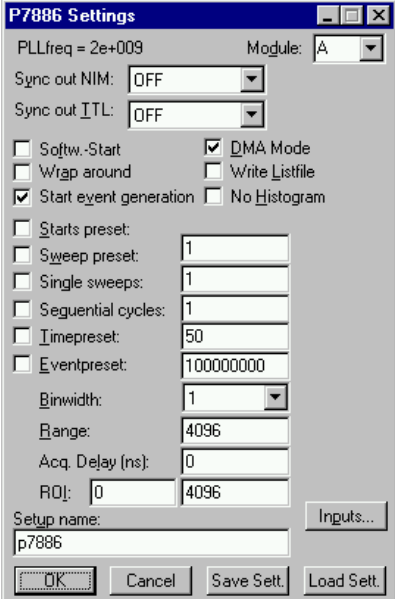

The 'P7886 Settings' dialog box is a standard Windows-style window with a title bar containing the text 'P7886 Settings' and window control buttons. The main area contains various settings for the P7886 device. At the top, 'PLLfreq = 2e+009' is displayed next to a 'Module:' dropdown menu set to 'A'. Below are 'Sync out NIM:' and 'Sync out I.TL:' dropdown menus, both set to 'OFF'. A group of checkboxes includes 'Softw.-Start', 'Wrap around', 'Start event generation' (checked), 'DMA Mode' (checked), 'Write Listfile', and 'No Histogram'. Further down are 'Starts preset:', 'Sweep preset:' (set to 1), 'Single sweeps:' (set to 1), 'Sequential cycles:' (set to 1), 'Timepreset:' (set to 50), and 'Eventpreset:' (set to 100000000). Below these are 'Binwidth:' (set to 1), 'Range:' (set to 4096), 'Acq. Delay (ns):' (set to 0), and 'ROI:' (set to 0 and 4096). At the bottom, there is a 'Setup name:' field containing 'p7886' and an 'Inputs...' button. The dialog concludes with 'OK', 'Cancel', 'Save Sett.', and 'Load Sett.' buttons.

Figure 6.15: P7886 Settings dialog box

Data...

The Data dialog box allows to perform all the P7886 data operations (ref. the Server description).

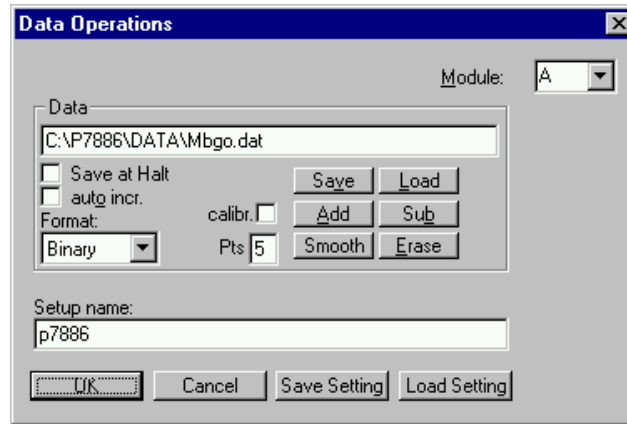

Figure 6.16: Data Operations dialog box

System...

The System Definition dialog box allows to make all the respective P7886 settings (See P7886 Server documentation).

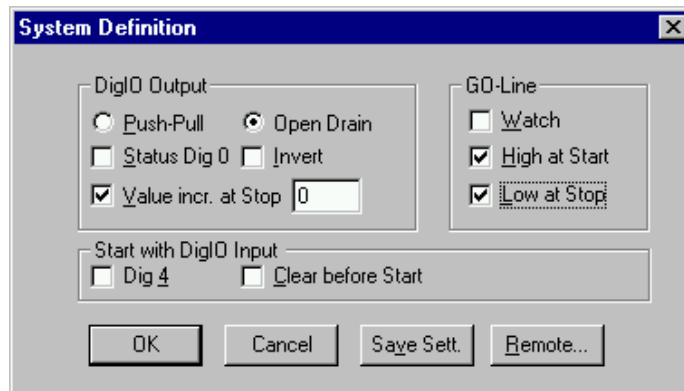

Figure 6.17: System Definition dialog box

Tool Bar...

Selecting the Tool Bar Menu item opens the Tool Bar Dialog Box. It allows to arrange the icons in the Tool Bar.

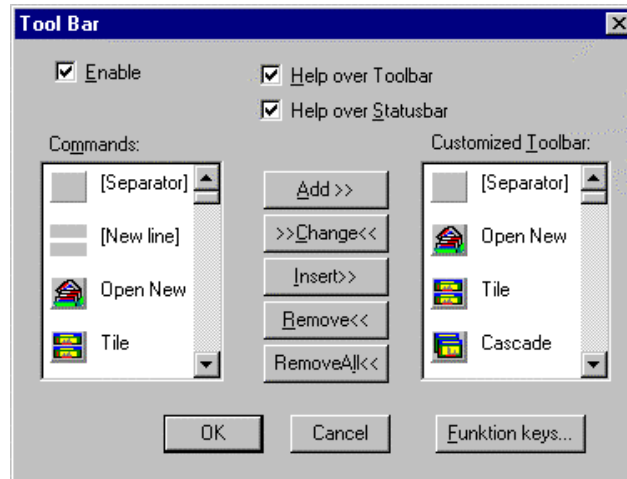

Figure 6.18: Tool Bar dialog box

If it is enabled, an array of icons in the MCDWIN Menu is shown. Clicking the left mouse button with the cursor positioned on an icon, the user can perform a corresponding MCDWIN Menu command very quick.

It is also possible to include icons for free programmable function keys F1...F12 into the Toolbar. The function keys can be programmed in the Function keys dialog. It can be accessed either by clicking the "Function keys..." button or directly from the options menu.

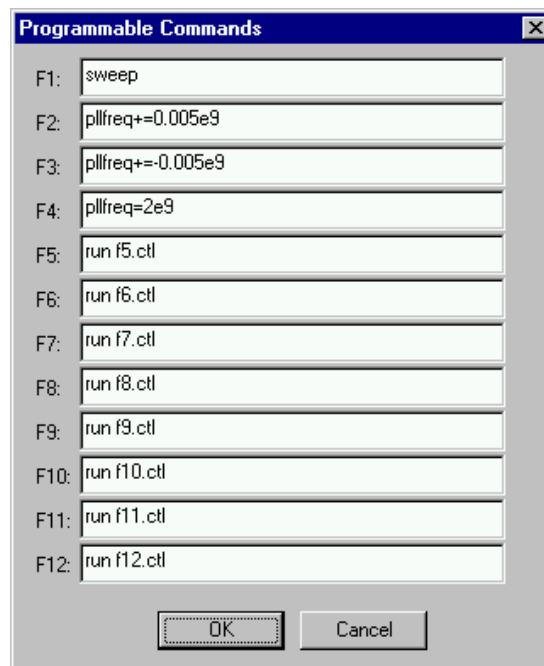

Figure 6.19: Function keys dialog box

The functions can be executed by clicking the corresponding icon in the toolbar or by the corresponding function key on the keyboard simultaneously with the CTRL key. The MCDWIN window must be the active on the desktop and have the focus.

Status bar

With this menu item the Status bar at the bottom of the MCDWIN main window can be switched on or off. A corresponding checkmark shows if it is active or not. The Status bar usually shows if an acquisition is running. When the left mouse button is held down while the mouse cursor is on a toolbar icon, it displays a short help message what the toolbar icon does.

Status window

The same way it is possible to hide or show the status window at the left side of the MCDWIN main window.

Save

Stores all parameters defined in the Options menu to the MCDWIN.CNF config file.

Save As...

Stores all parameters defined in the Options menu to a user defined config file.

Retrieve...

Loads a new configuration.

6.5. Action Menu

The Action Menu or corresponding toolbar icons contain the commands to start, stop, continue and erase a measurement. If more than one system is formed, also more actions menus are available, otherwise they are grayed or disabled.

Start



The Start toolbar button erases the histogram data and starts a new measurement.

Halt



The Halt toolbar button stops a measurement.

Continue



The Continue toolbar button continues a measurement.

Erase



The Erase toolbar button clears the histogram data.

7. Appendix

7.1. Performance Characteristics

7.1.1. General

Resolution FWHM ⁴ :	at 1 ms \cong 2,000,000 chs over 1 hour: FAST-NIM inputs: typ. < 400 ps Discriminator inputs: typ. < 400 ps
	Oven stabilized option: at 100 ms \cong 200,000,000 chs over 24 hours: FAST-NIM inputs: typ. < 500 ps Discriminator inputs: TBD
Differential non-linearity: < \pm 1 %
Start / trigger delay:	FAST-NIM inputs: \leq 10 ns Discriminator inputs: \leq 10 ns
Deadtime:	End of sweep: < 200 ns between time bins: none

7.1.2. Timebase

Reference oscillator:	Nominal frequency: 10.000 MHz Initial accuracy (25°C): $\leq \pm$ 50 ppm Frequency stability: in operating temperature range: $\leq \pm$ 100 ppm
Oven stabilized option:	Nominal frequency: 10.000 MHz Adjustment tolerance: $\leq \pm$ 0.3 ppm Frequency stability: in operating temperature range: $\leq \pm$ 0.03 ppm vs. Supply voltage change \pm 5 %: $\leq \pm$ 4.0 * 10 ⁻⁹ vs. Short term: $\leq \pm$ 2.0 * 10 ⁻¹⁰ /s Aging: $\leq \pm$ 1.5 * 10 ⁻⁹ /day 0.1 * 10 ⁻⁶ /year after 30 days of operation Warm-up time: \leq 1 min.
Synthesizer frequency:	Nominal: 2 GHz Tuning range: 1.95 – 2.15 GHz

7.1.3. Data Throughput

DMA data rate ⁵ :	(Pentium III / 533MHz / PC133) \approx 10 Mevents/s (AMD-Athlon / 600 MHz / PC100) \approx 10 Mevents/s (Pentium III / 450MHz) \approx 6 Mevents/s (AMD-K6 / 200 MHz) \approx 2 Mevents/s
------------------------------	--

⁴ Full width at half maximum

⁵ depends largely on the computer used

7.2. Specification

7.2.1. Absolute Maximum Ratings

Input voltage:	any multi I/O port: -0.5 to VCC + 0.5 V
	any FAST-NIM input: +0.5 to -2.5 V
	any discriminator input: ± 3.0 V (relative to threshold)
 -2.5 to +3.8 V (absolute)
DC Input current (any port):	any multi I/O port ± 20 mA
	any FAST-NIM input: ± 100 mA
	any discriminator input: ± 100 mA

7.2.2. Recommended Operating Conditions

Supply voltage:	(from PC power supply)..... +5 V, +12 V, -12 V
Temperature range: 0 to 50°C
GO Line load: min. 1 kΩ to VCC
	or min. 2 k to GND

7.2.3. Power Requirements

Supply voltage:	VCC: +5 V ± 0.25 V
 +12 V ± 0.6 V
 -12 V ± 0.6 V
Supply current:	+5 V: typ. 450 mA
	+12 V: typ. 1200 mA
	-12 V: typ. 65 mA

7.2.4. Connectors

FAST-NIM START Input

Location: mounting bracket
Connector: female SMA
Impedance: 50 Ω
Threshold voltage:	(default = -0.4 V) -0.8 to -0.25 V
 in steps of 0.5 mV

±2 V START Input

Location: mounting bracket
Connector: female SMA
Impedance: 50 Ω
Threshold voltage:	(default = 0.0 V) -1.5 to +1.5 V
 in steps of 0.7 mV
Sensitivity: typ. 30 mV

Hysteresis: typ. 5...10 mV
 Bandwidth: (- 3dB) typ. 900 MHz

FAST-NIM STOP Input

Location: mounting bracket
 Connector:female SMA
 Impedance: 50 Ω
 Threshold voltage: (default = -0.4 V) -0.8 to -0.25 V
 in steps of 0.5 mV

±2 V STOP Input

Location: mounting bracket
 Connector:female SMA
 Impedance: 50 Ω
 Threshold voltage: (default = 0.0 V) -1.5 to +1.5 V
 in steps of 0.7 mV
 Sensitivity: typ. 30 mV
 Hysteresis: typ. 5...10 mV
 Bandwidth: (- 3dB) typ. 900 MHz

FAST-NIM SYNC_1 Output

Location: mounting bracket
 Connector:female SMA
 Impedance: 50 Ω
 Output HIGH voltage: (50 Ω load) typ. -0.0 V
 Output LOW voltage: (50 Ω load) typ. -0.8 V
 Output short circuit current: $V_{OUT} = GND$ typ. 28 mA

SYNC_2 Output

Location: ref. multi I/O port connector
 Output HIGH voltage: (at $POUT_i$) $I_{OutHIGH} = -12mA$ min. 2.4 V
 Output LOW voltage: (at $POUT_i$) $I_{OutLOW} = 16mA$ max. 0.45 V
 Output short circuit current: $V_{OUT} = GND$ ($R_{PULL} = \infty$, $R_{I/O} = 0\Omega$) -15 to -180 mA
 $V_{OUT} = 3.3 V$ ($R_{PULL} = \infty$, $R_{I/O} = 0\Omega$) 40 to 210 mA

Digital I/O 0...7

Location: ref. multi I/O port connector
 R PULL : (default) 1.0 kΩ
 R I/O: (default) 22 Ω

Input HIGH voltage:	(at PIN _i , ref Figure 3.10.) ⁶	min. 2.0 V
Input LOW voltage:	(at PIN _i)	max. 1.2 V
Output HIGH voltage:	(at POUT _i) I _{OutHIGH} = -16mA	min. 2.4 V
Output LOW voltage:	(at POUT _i) I _{OutLOW} = 15mA	max. 0.45 V
Output short circuit current ⁷ :	V _{OUT} = GND (R _{PULL} = ∞, R _{I/O} = 0Ω)	-15 to -180 mA
	V _{OUT} = 3.3 V (R _{PULL} = ∞, R _{I/O} = 0Ω)	40 to 210 mA

GO-Line

Location:	PCI board
	ref. multi I/O port connector
Connector:	2 pin header on PCI board:	LUMBERG 2,5 MSFW 2(MBX)
	suitable socket connector:	LUMBERG 2,5 MBX 2
Line Type :	open drain / wired-AND
Pull-Resistors:	100kΩ to VCC
Input HIGH voltage:	min. 2.0 V
Input LOW voltage:	max. 1.2 V
Output LOW voltage:	I _{OutLOW} = 15mA	max. 0.8 V

Extra Power Supply

Location:	PCI board
Connector:	3.5" floppy power supply

7.2.5. Physical

PCI long board (ISA assembly, 5V)

Size:	(incl. retainer)	341 x 107 mm
Weight:	(board alone)	≈ 320 g

7.3. Accessories

- SMA – BNC adapter cables
- Multi I/O port connector cable
- Extra power supply cable

⁶ Note: input and output voltages are measured at the internal logic pads not at the external connectors. Thus, the corresponding pull and series resistors must be considered to get the external voltages

⁷ Only one output at a time. Duration should not exceed 30 seconds.

7.4. Troubleshooting

- Error message "**P7886 A not found or FASTMPA device driver not installed!**" at the first start of the software:
Maybe you did not install the device drivers. Change to the subdirectory \driver on your P7886 installation disk and run install.bat to install the driver for the P7886 board

